

Sicherungsstift und
Sicherungsboden
optional erhältlich

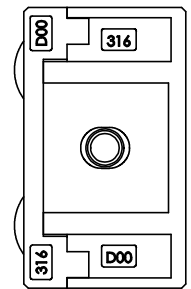

* lichter Abstand zwischen
Glas und Pfosten

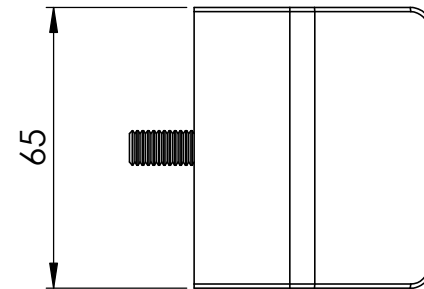

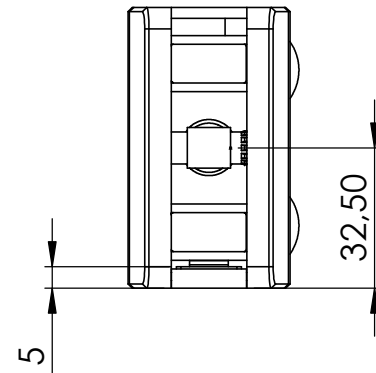
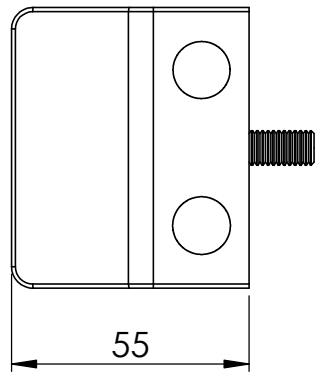
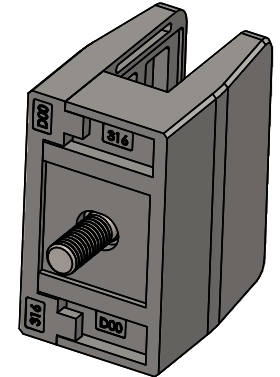
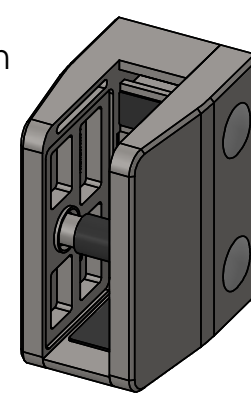
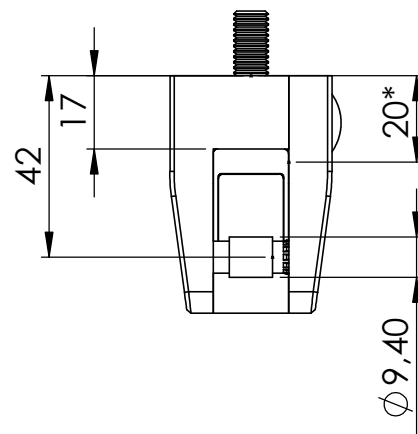
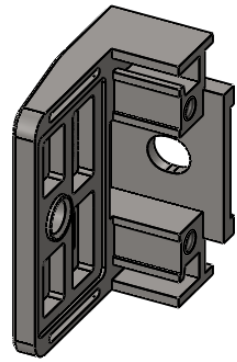
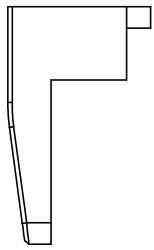
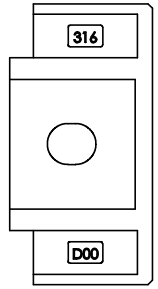
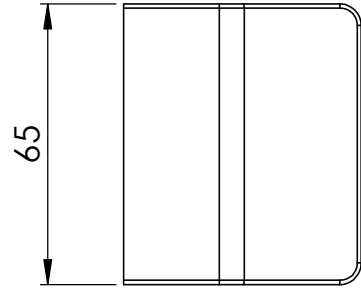
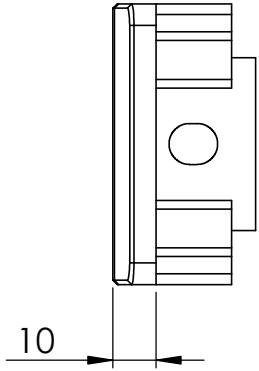
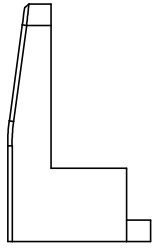
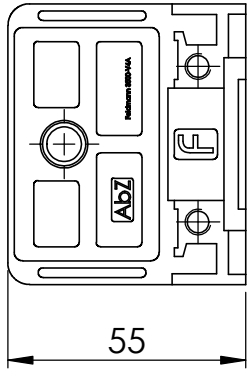

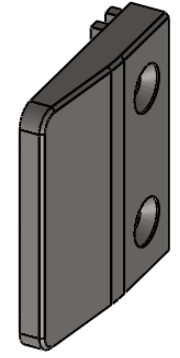
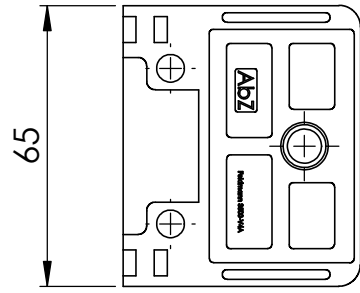
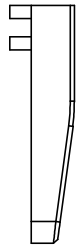
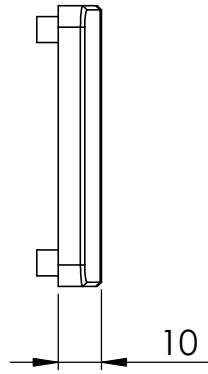
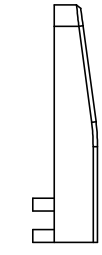
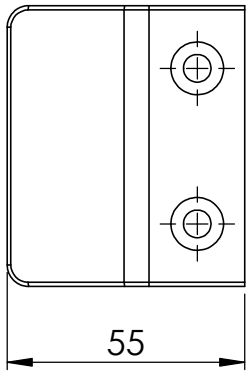

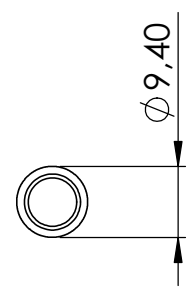
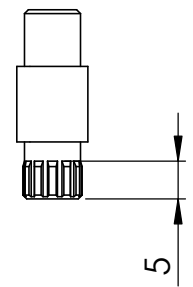
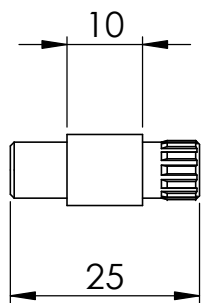

*Sicherungsstift optional erhältlich

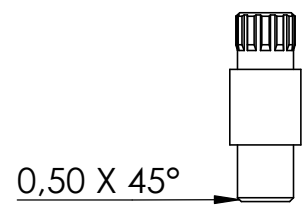
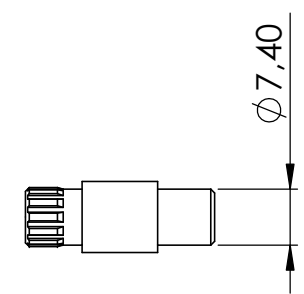

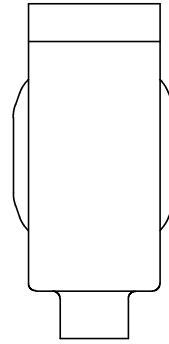

*Sicherungsboden optional erhältlich

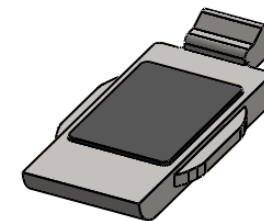
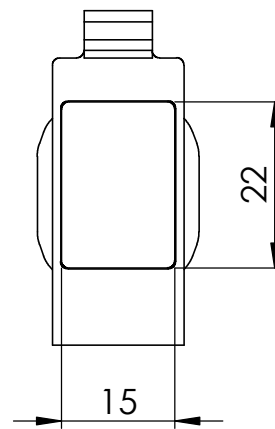
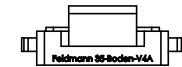
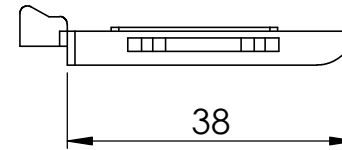
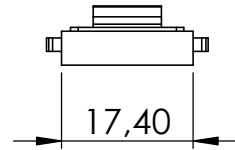
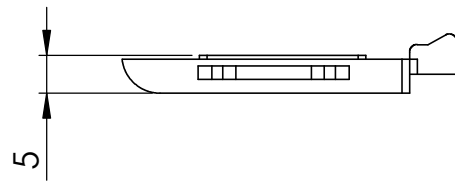

| | | |
|---|-------------------------|---|
| 4 | DIN 912 M8 x 20 --- 20S | 1 |
| 5 | 35-Stift* | 1 |
| 6 | 35-Kappe | 2 |
| 7 | Haltegummi | 2 |
| 8 | 35-Boden-V4A* | 1 |

*optional erhältlich

