

SCHNITT B-B

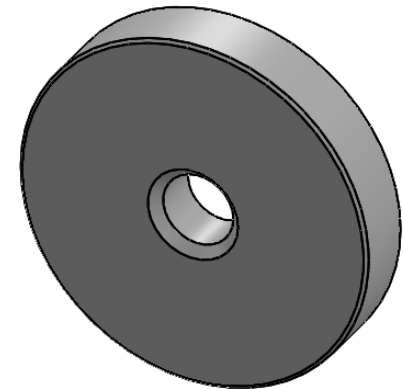

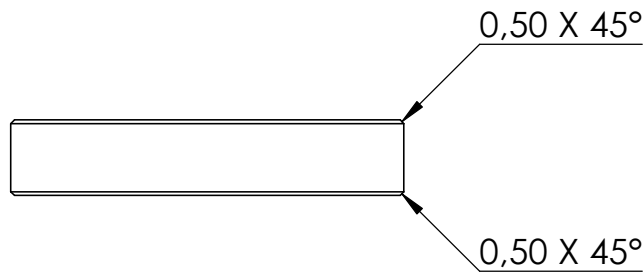

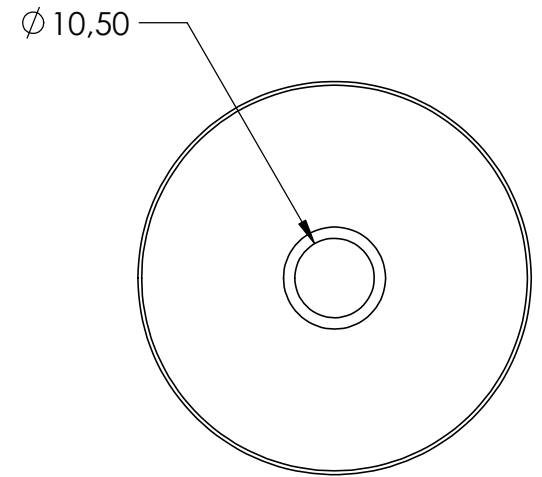

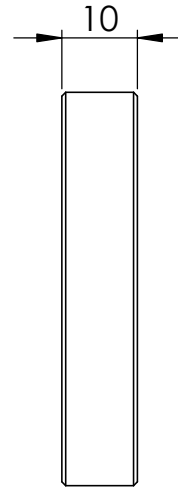
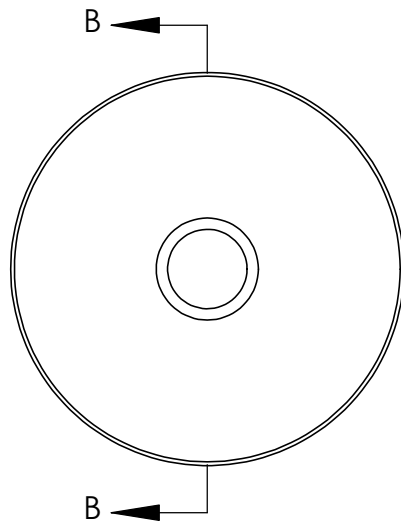
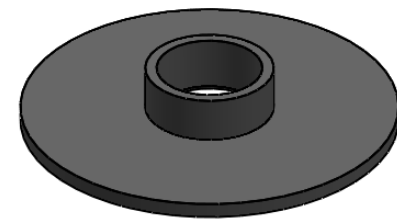
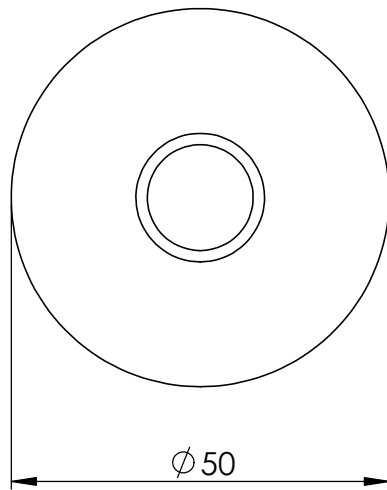
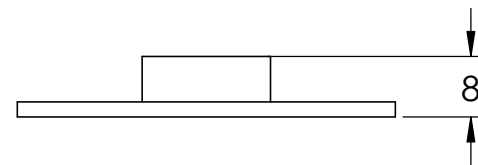
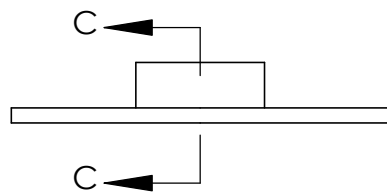
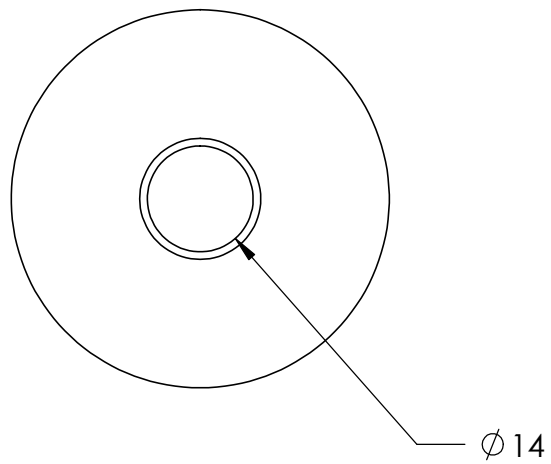
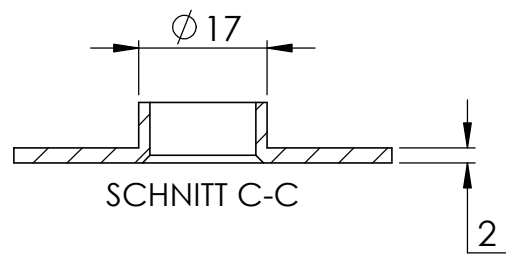
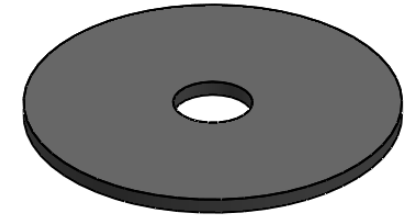
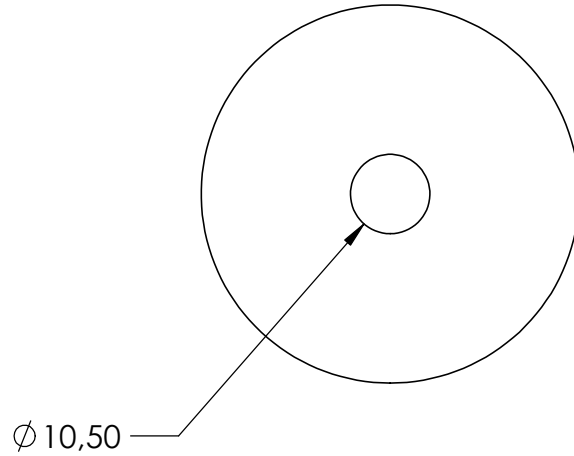
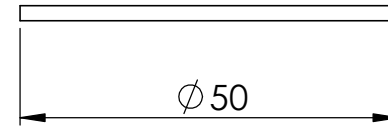
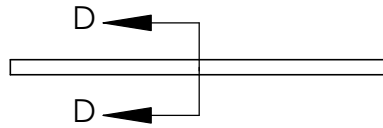
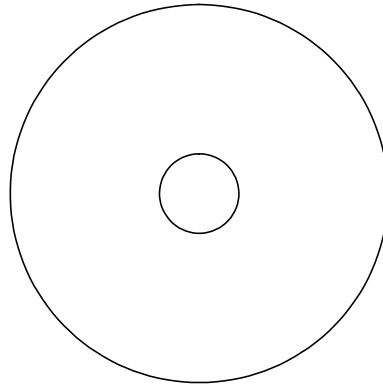
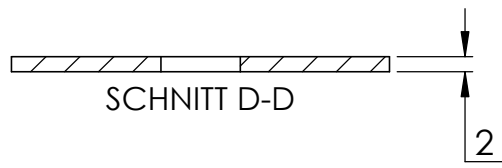
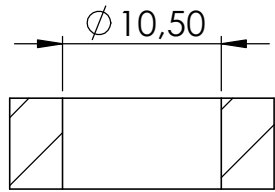
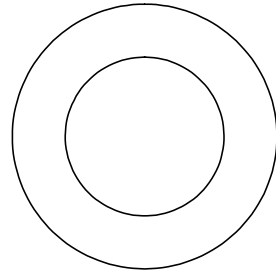

SCHNITT F-F

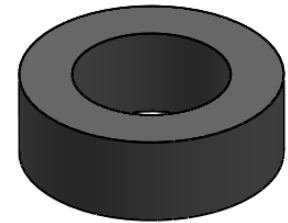
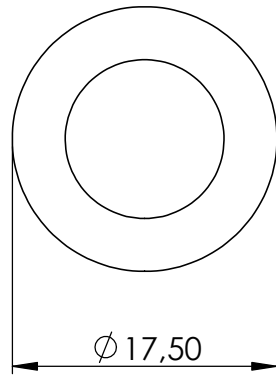
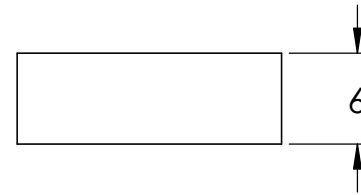
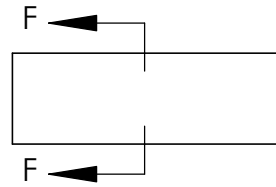

4	DIN7991 M10x80	1
5	60195-240-S Teil2	1
6	60195-240-S Teil5	1

