

\*lichter Abstand zwischen  
Glas und Pfosten

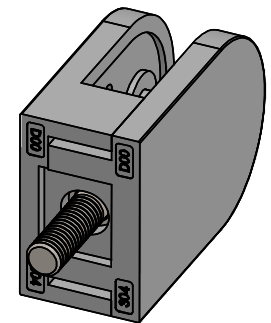

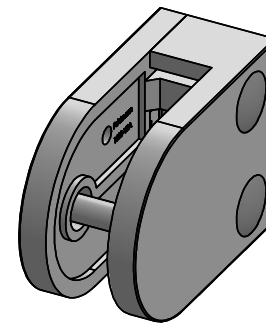

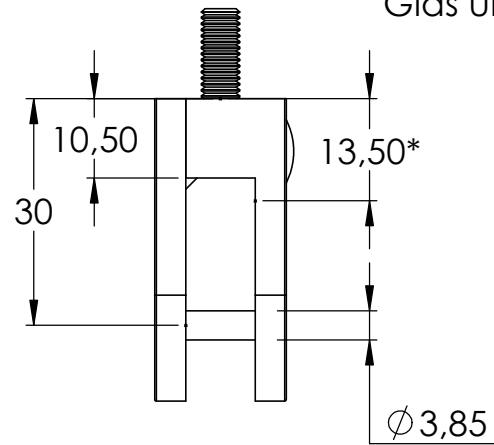

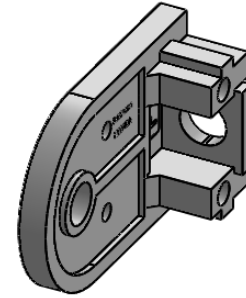
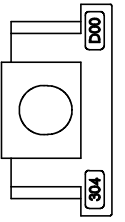
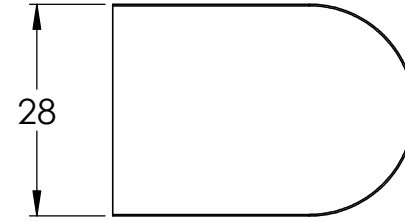
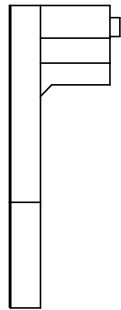
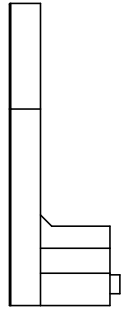
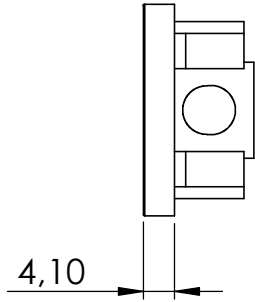
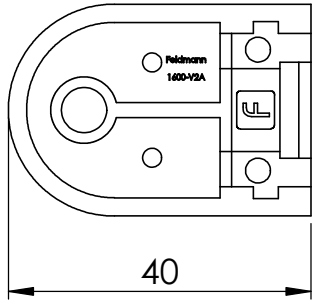
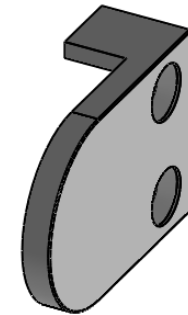
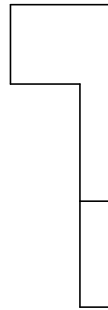
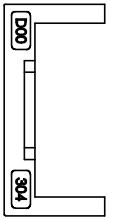
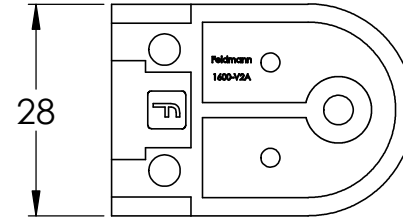
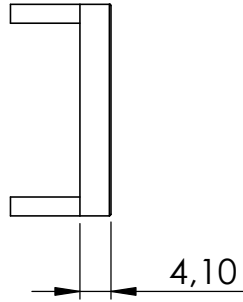
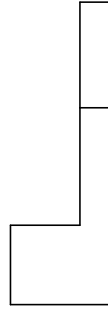
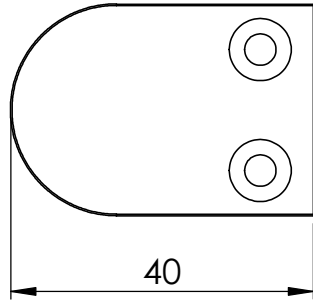
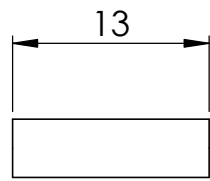

$\phi 3,85$

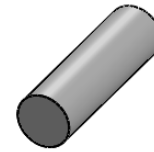

4	DIN 7991 - M4 x 10 --- 10S	2
5	16-Kappe	2
6	DIN 7984 - M5 x 16 --- 16S	1

