

1 X 45°

0,20 X 45°

0,50 X 45°

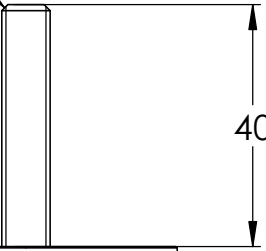

40

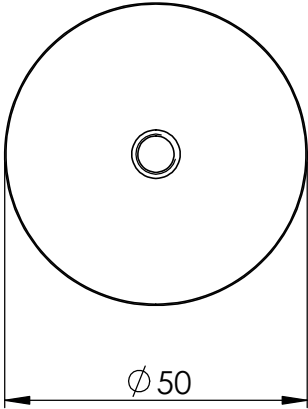

Ø 50

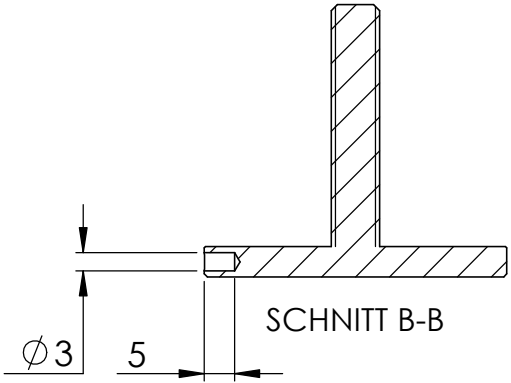

Ø 3

5

SCHNITT B-B

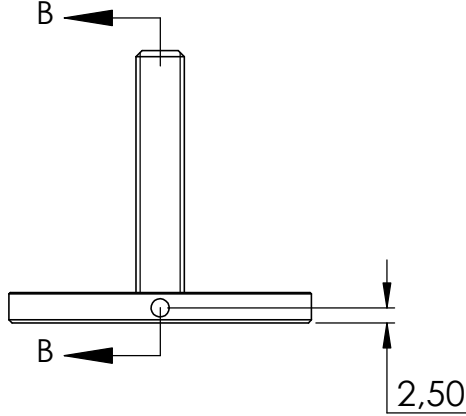

B

B

2,50

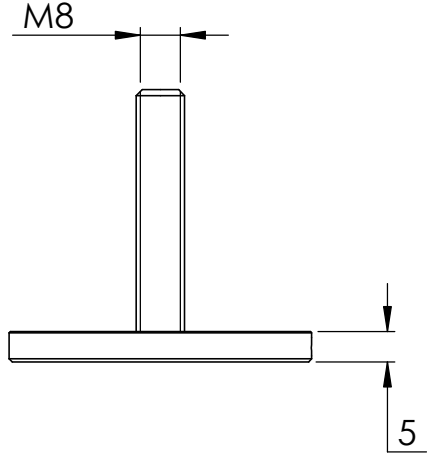

M8

5

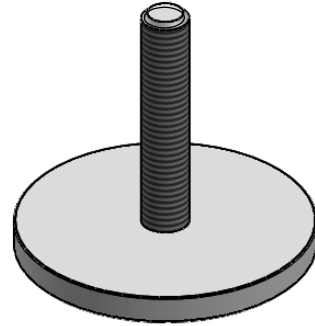

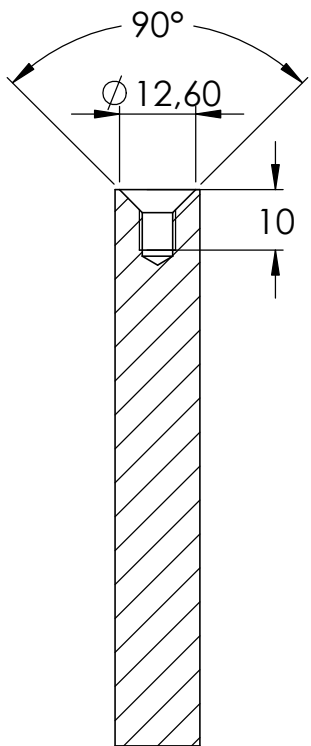

SCHNITT C-C

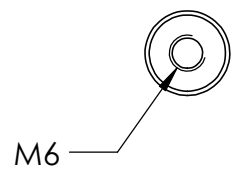
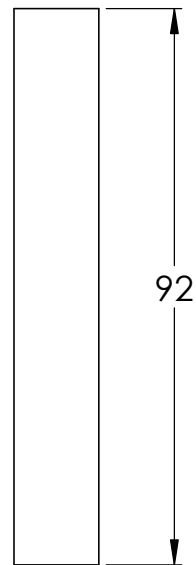
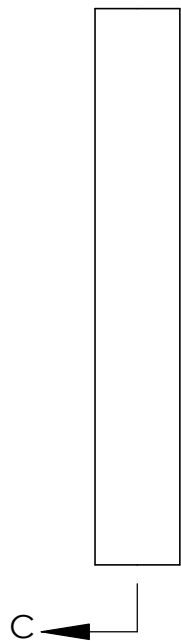
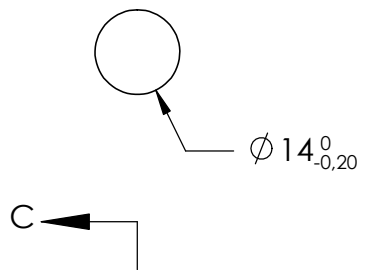

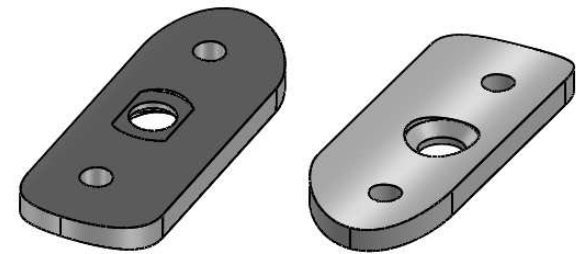
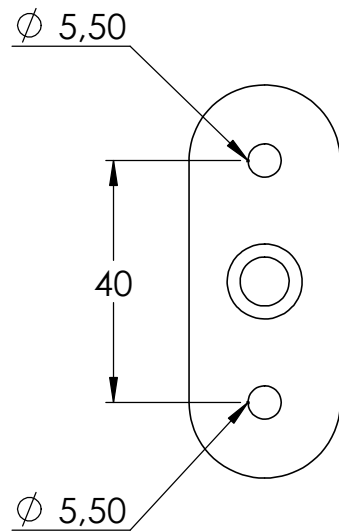
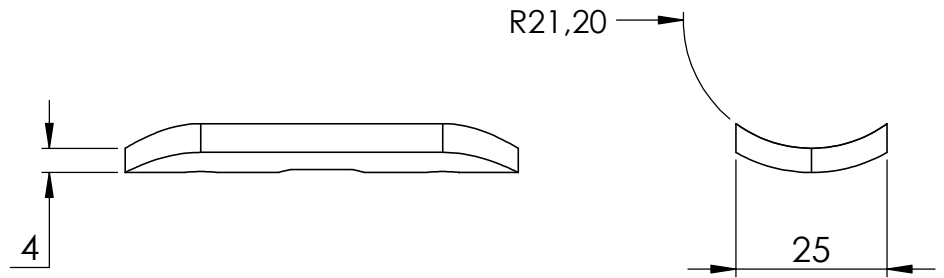
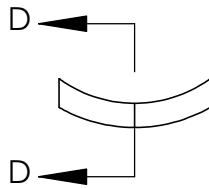
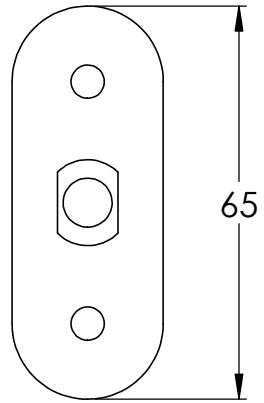
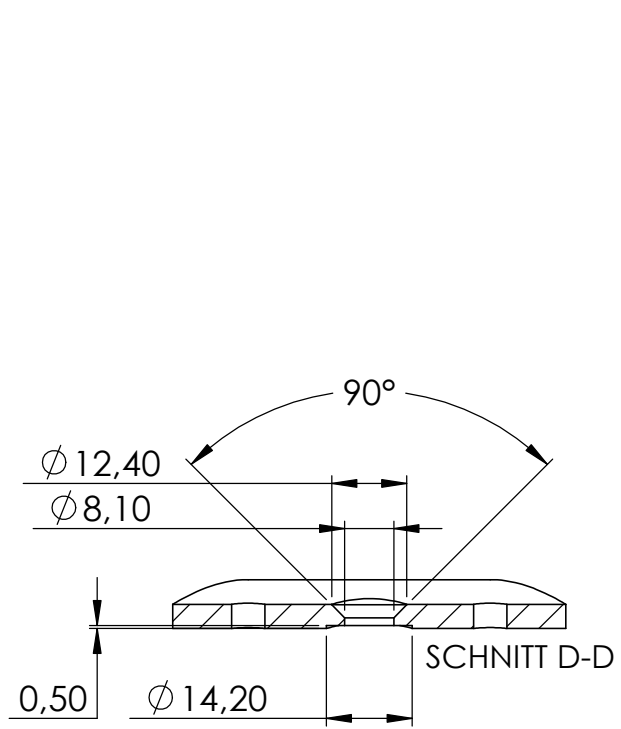

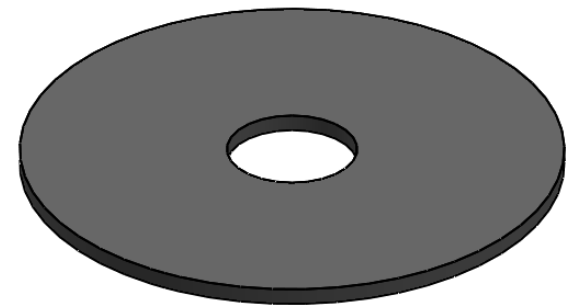
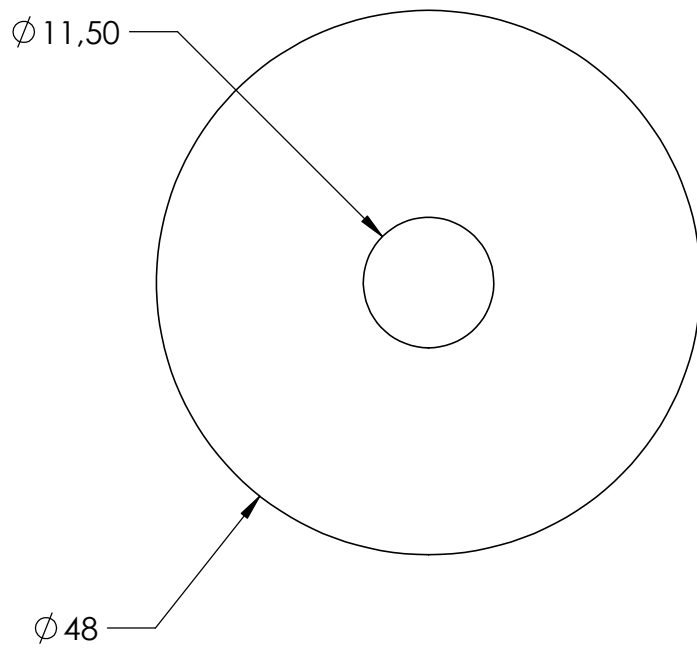
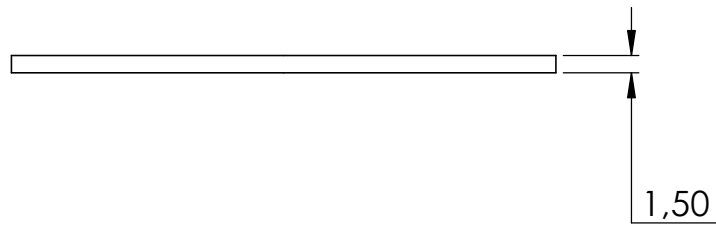

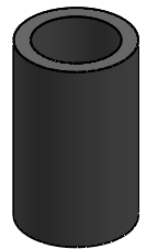
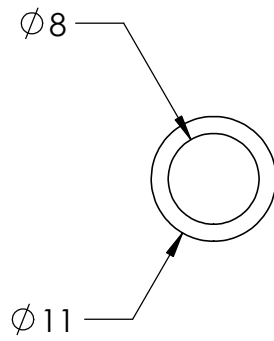
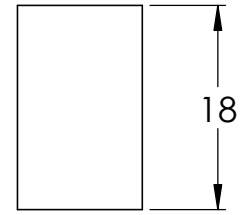
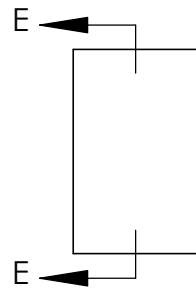
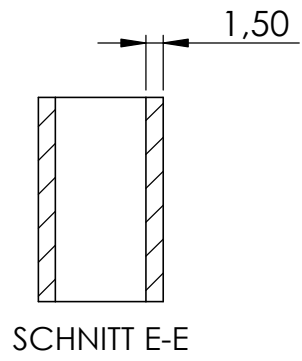

4	50351-240 Teil4	1
5	DIN7991 M6x14	1
6	DIN 913 M5x5	1
7	50351-240 Teil5	2
8	50351-240 Teil6	1

