

C-C

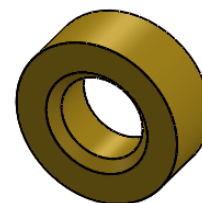

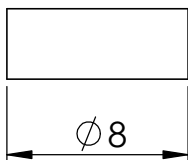

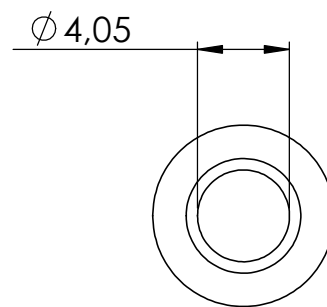

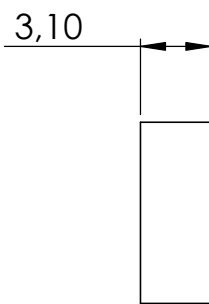
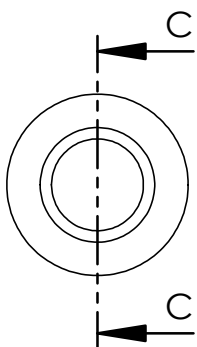
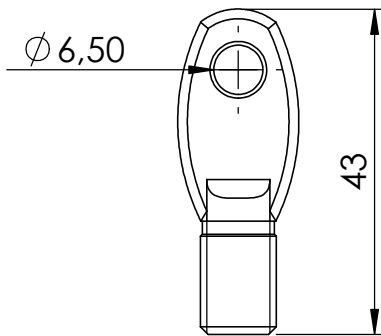
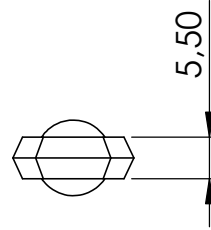
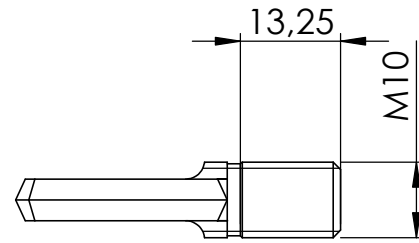
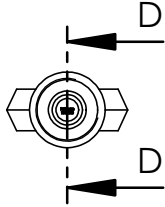
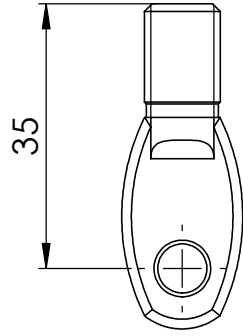
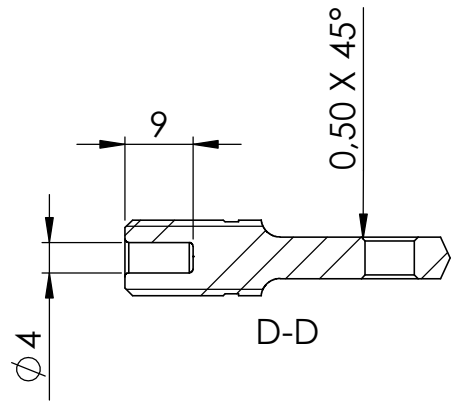
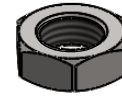
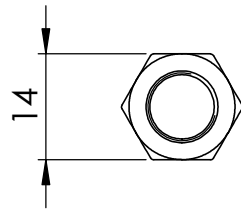
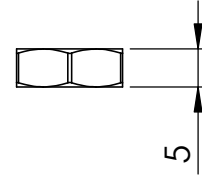
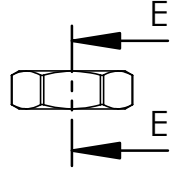
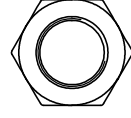
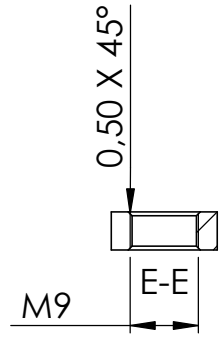
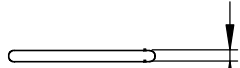
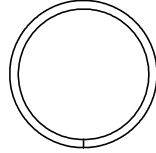
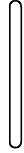
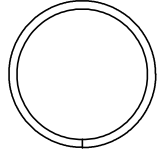
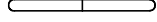
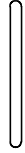

0,50



4	10160003 Teil1	1
5	10160003 Teil5	1
6	10160003 Teil6	1

