

$\phi 7$

9

0,50 X 45°

D-D

52

$\phi 12,50$

67

M16

8,50

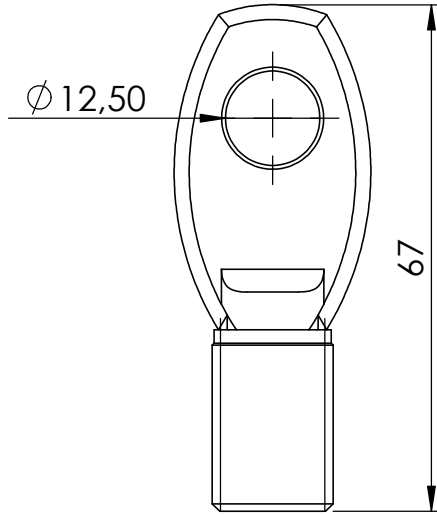
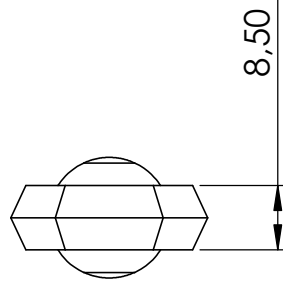
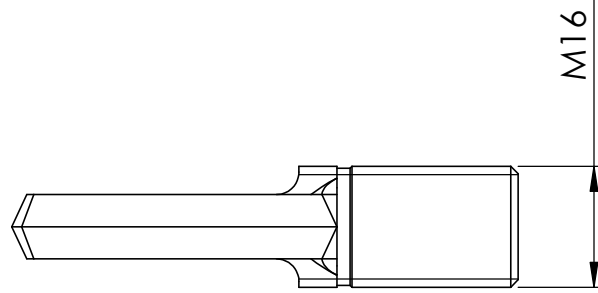
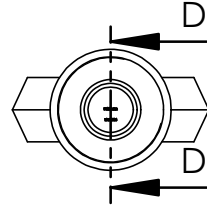
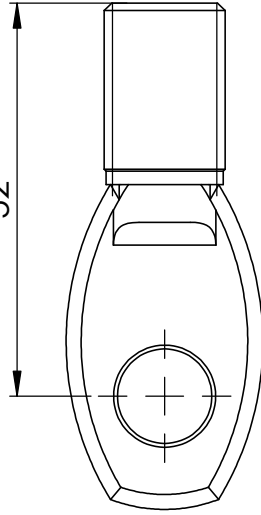

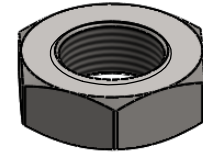
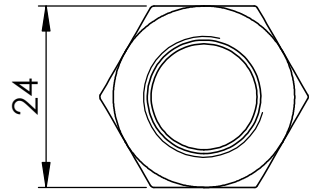
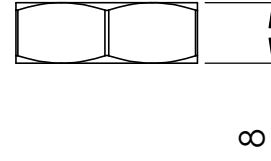
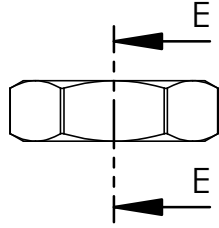
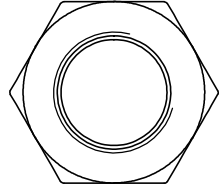
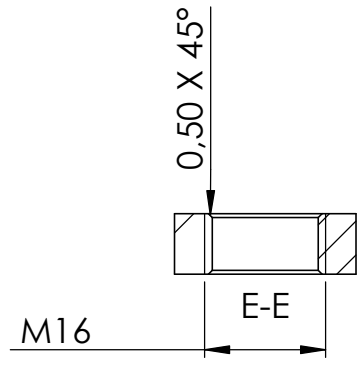

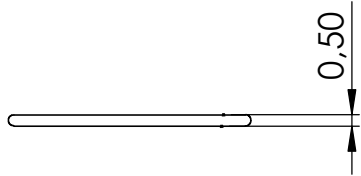
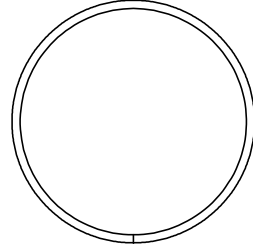
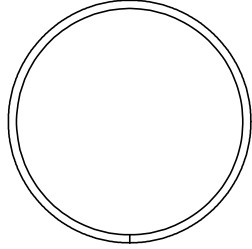
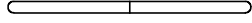

4	10160006 Teil1	1
5	10160006 Teil5	1
6	10160006 Teil6	1

