

SCHNITT A-A

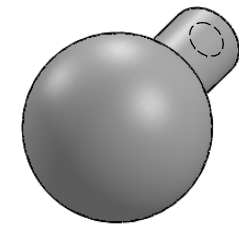

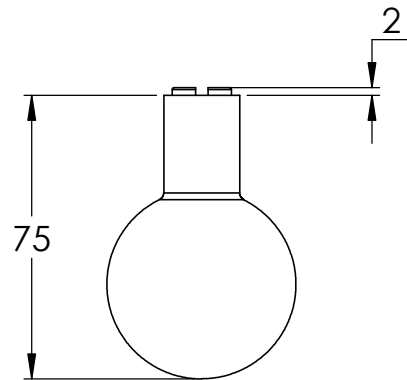

SCHNITT B-B

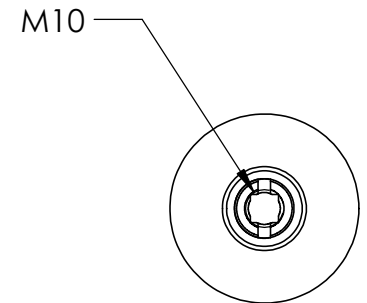
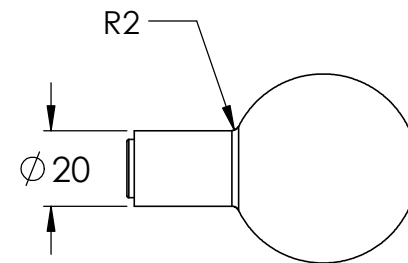
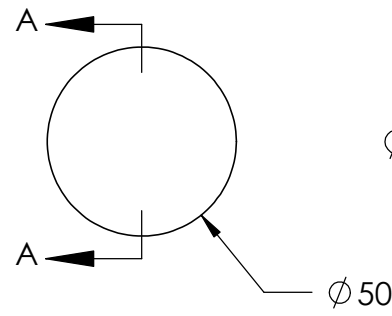
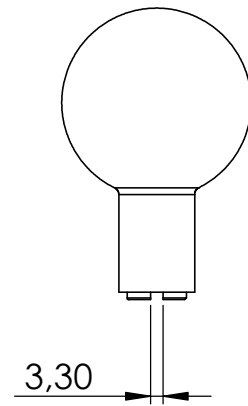
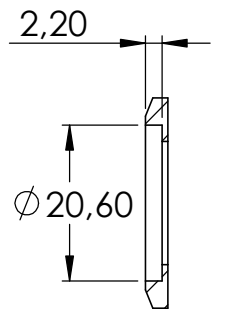
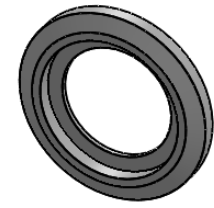
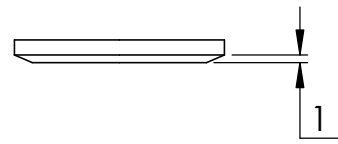
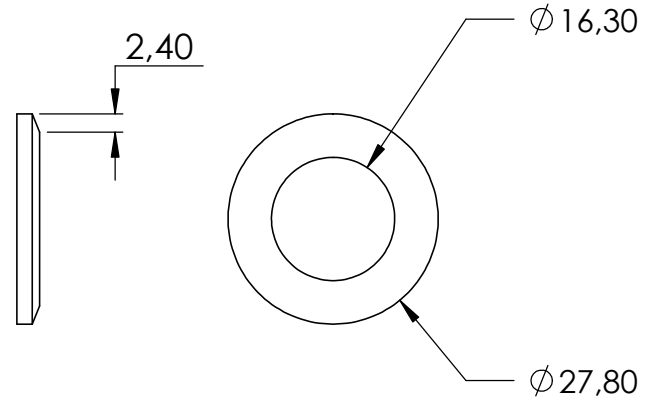
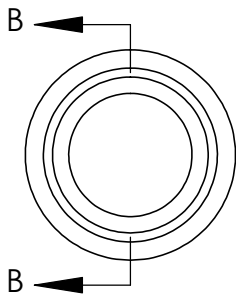
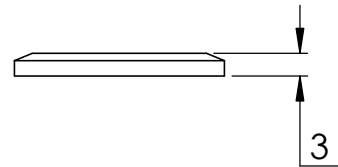

SCHNITT C-C

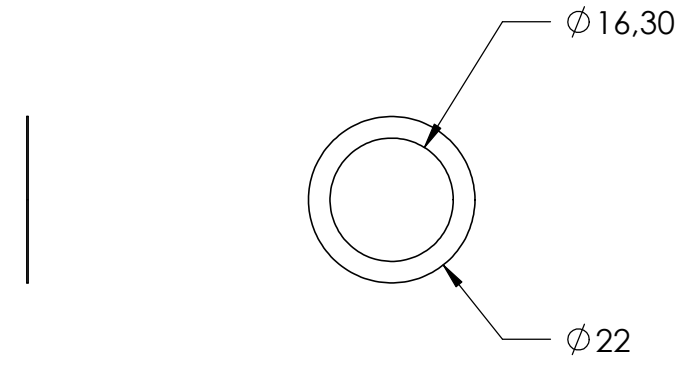
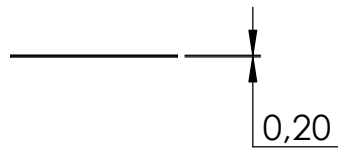
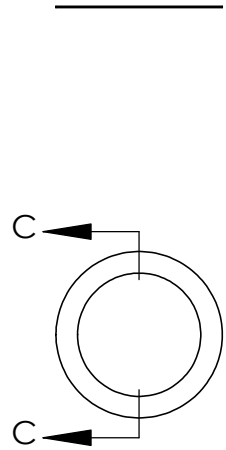

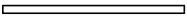

SCHNITT D-D

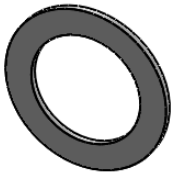
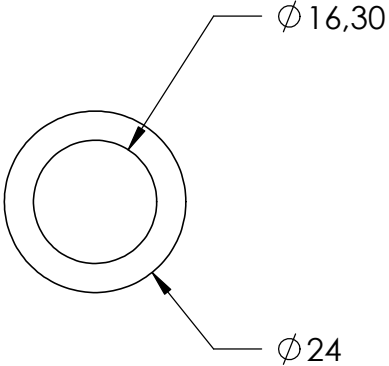
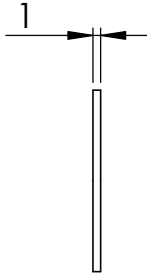
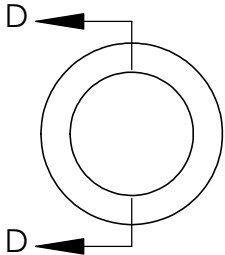

SCHNITT E-E

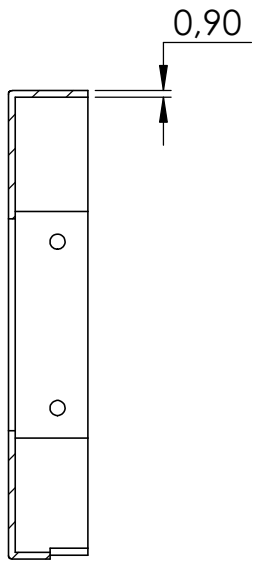

$\varnothing 28$

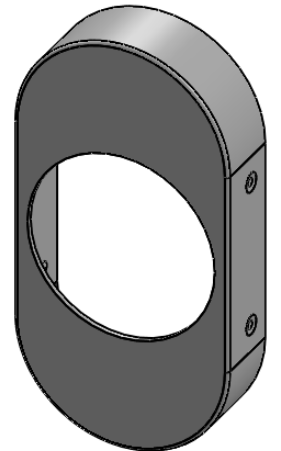
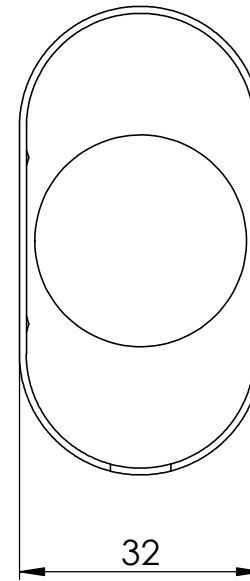
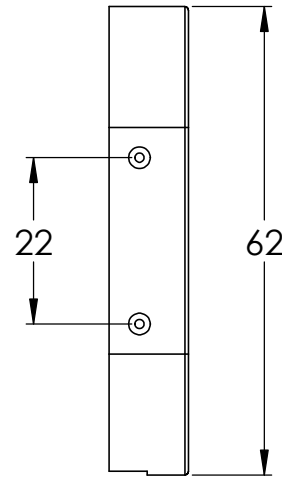
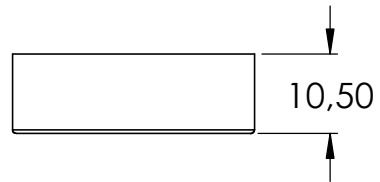
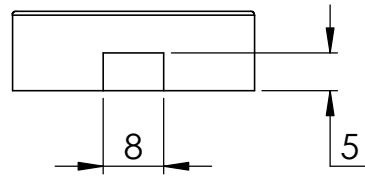
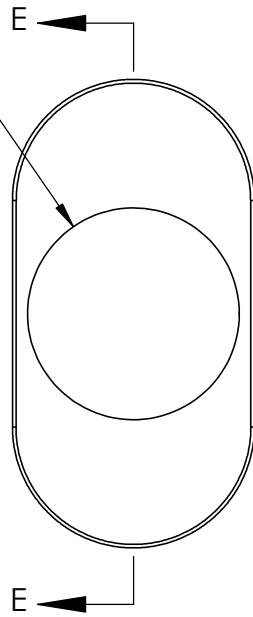

SCHNITT F-F

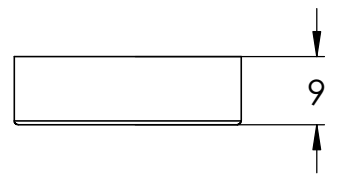
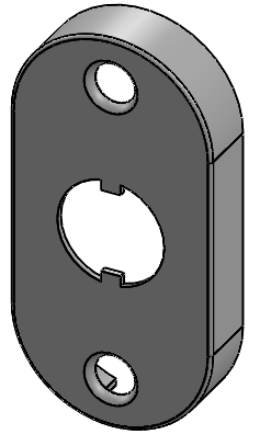
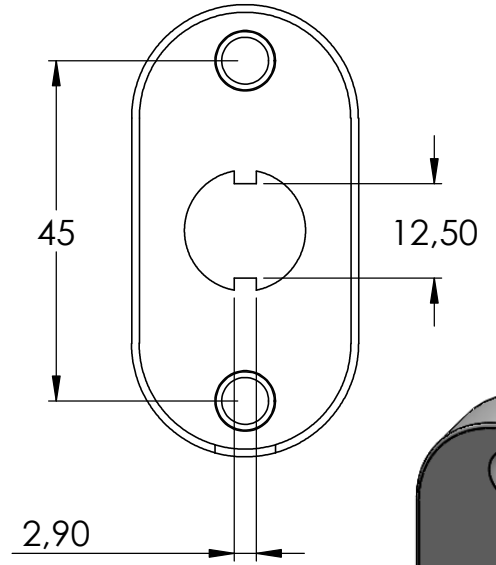
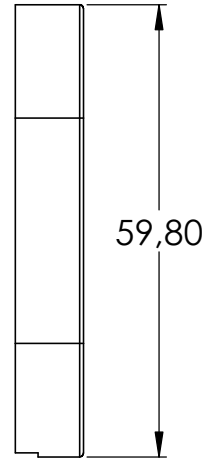
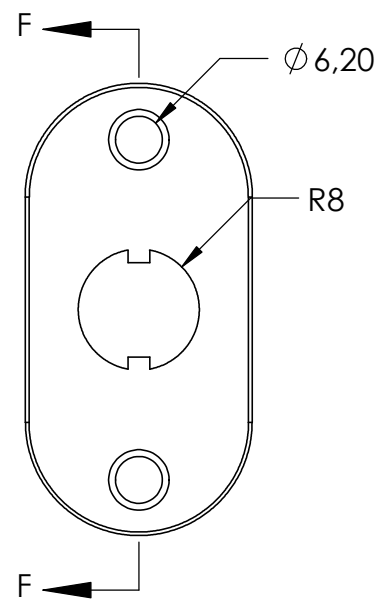
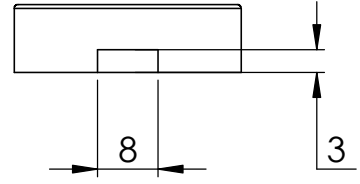
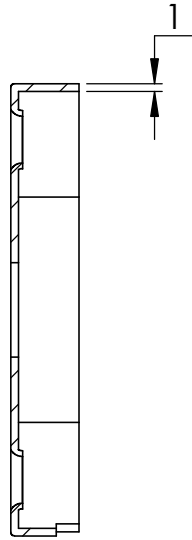

4	213-VA-F Teil4	1
5	213-VA-F Teil5	1
6	213-VA-F Teil1	1
7	DIN 931 M10x20	1
8	DIN 965 M4x18	2

