

SCHNITT A-A

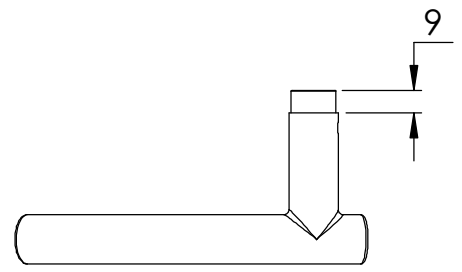

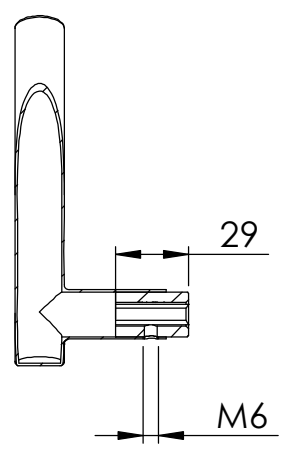

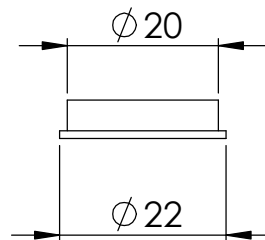
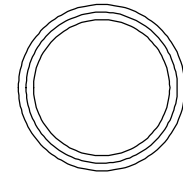
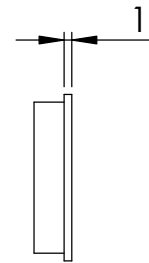
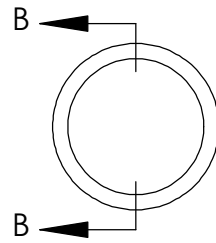
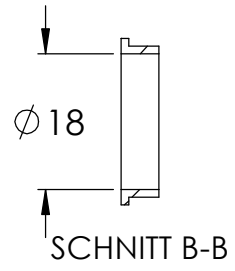
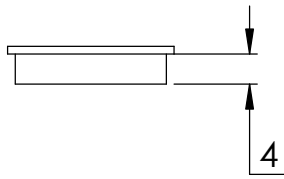
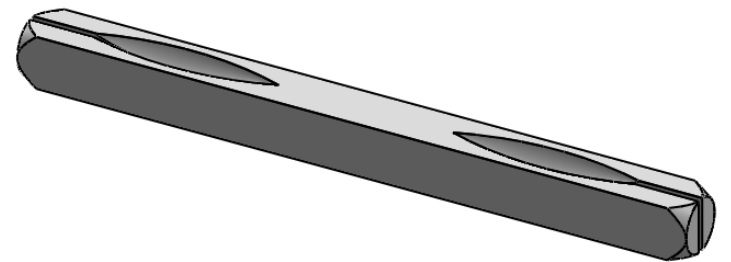
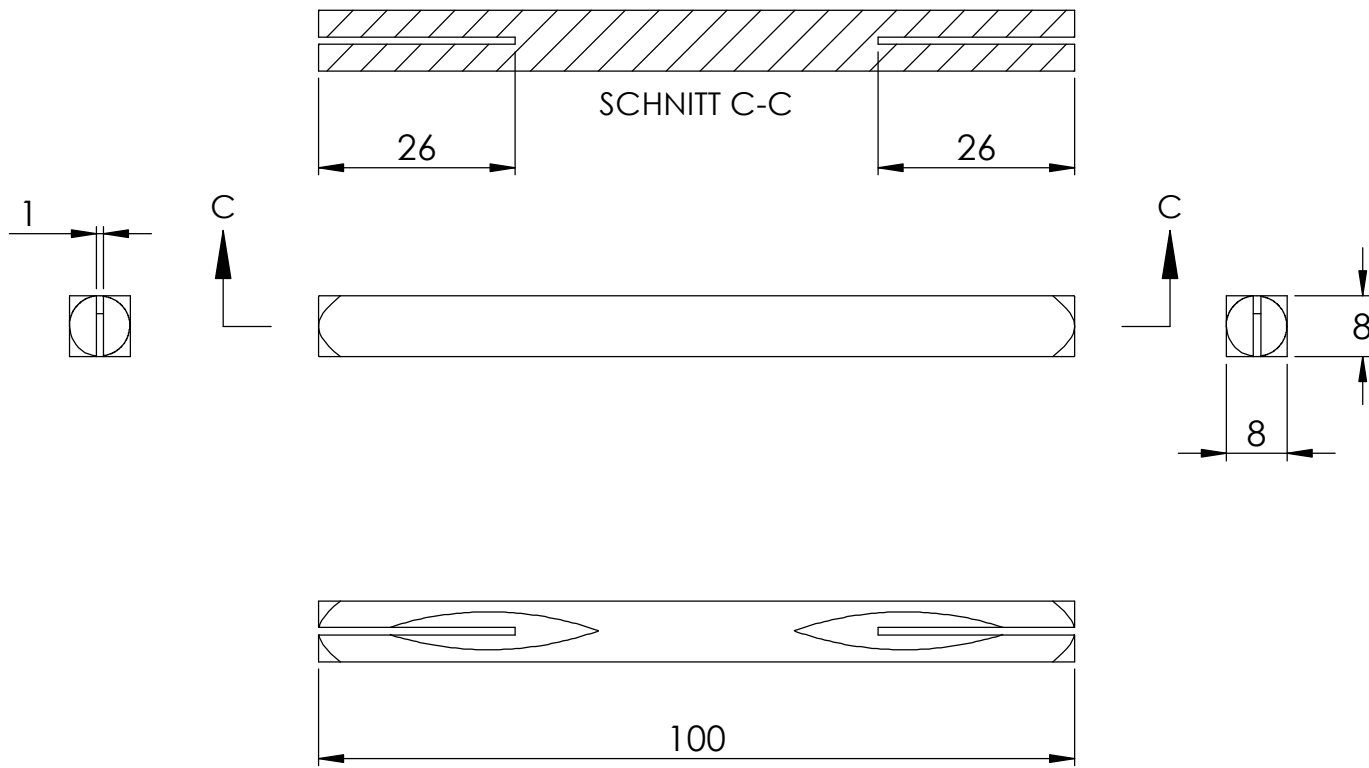

4	56651-240 Teil3	2
5	DIN 914 M6x6	2

