

4 x M8 Gewinde (180° versetzt)

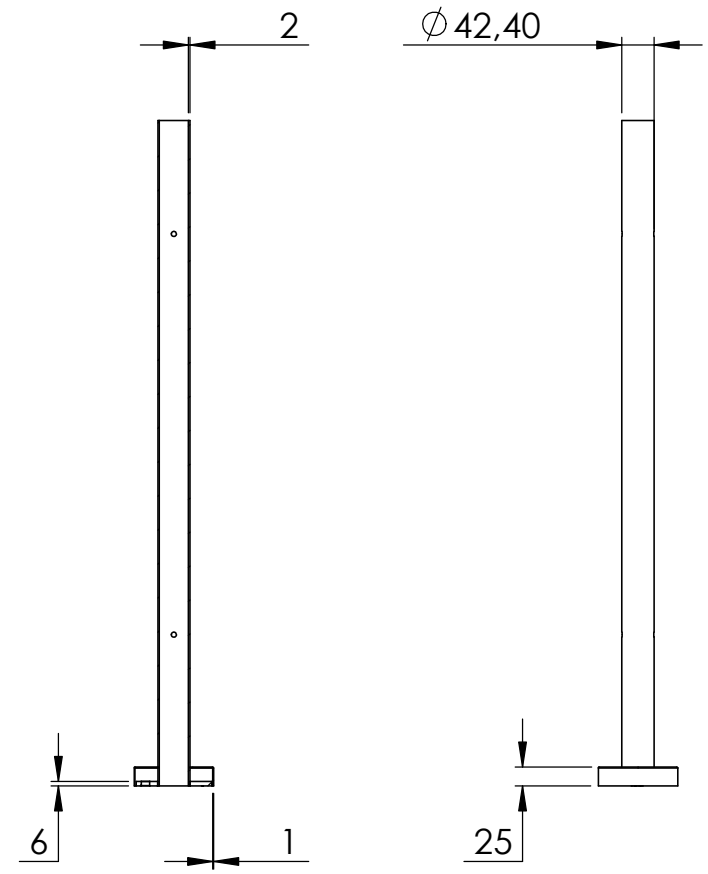

SCHNITT A-A

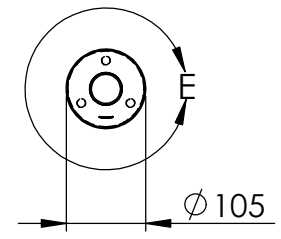
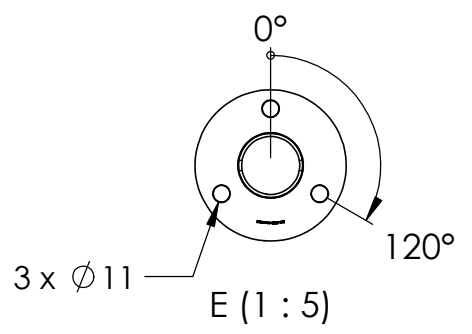
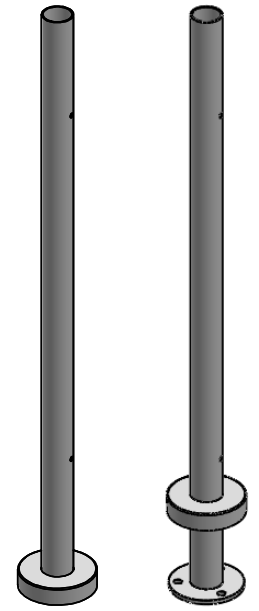

4 x M8 Gewinde (180° versetzt)

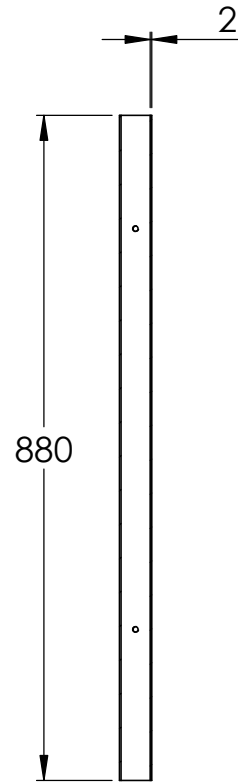
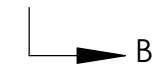
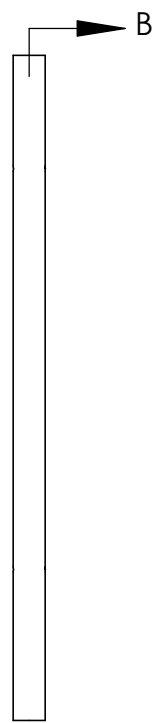
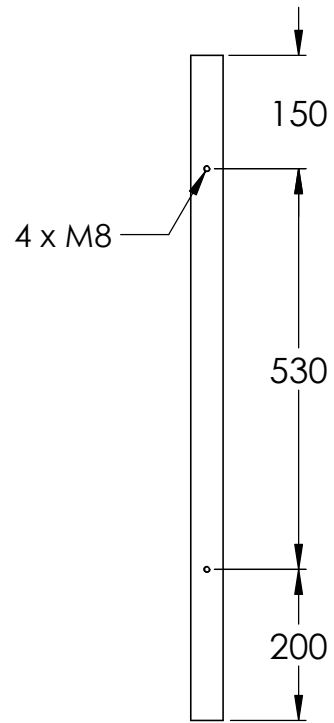

SCHNITT B-B

