

Tragkraft: 150kg
Gilt für 2 Bänder

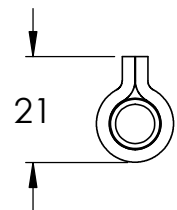

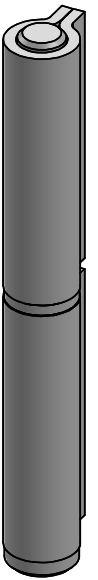

SCHNITT A-A

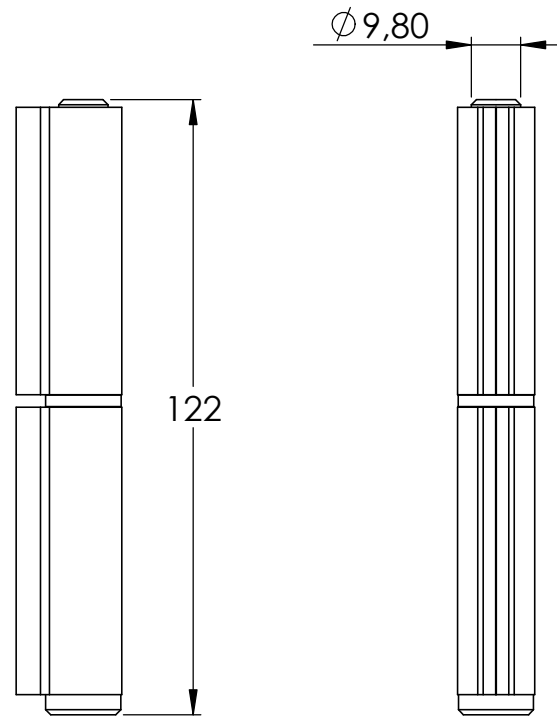
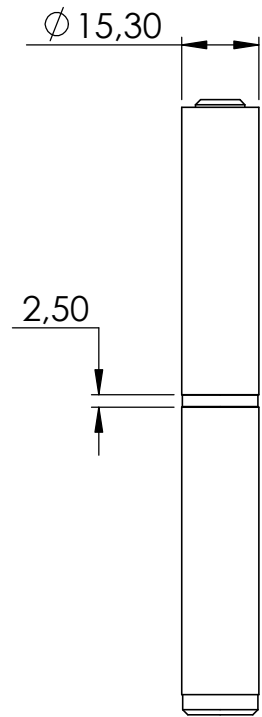
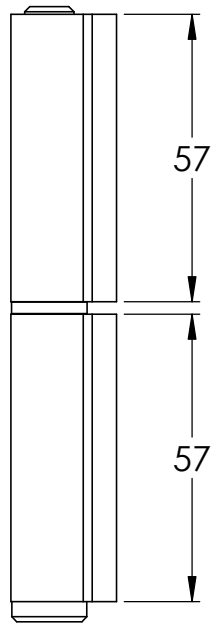
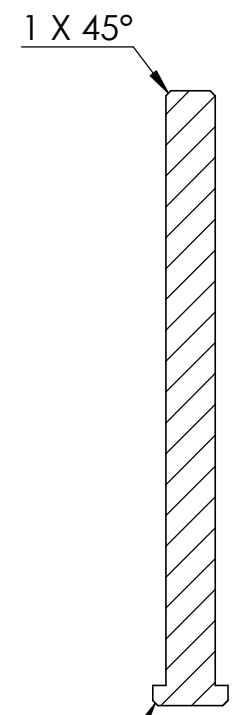
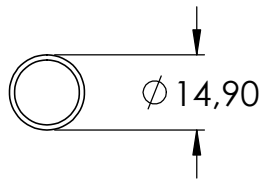
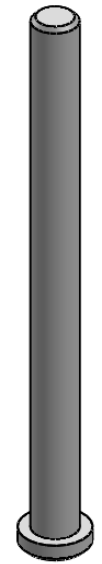
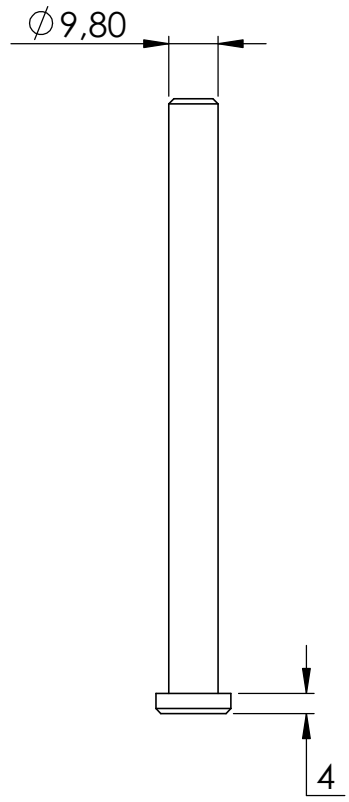
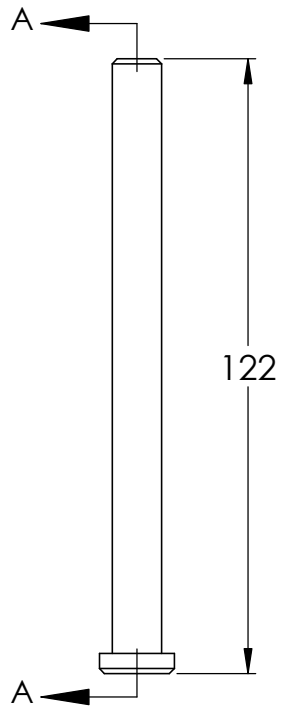

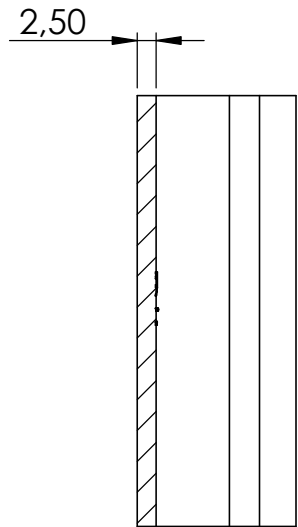
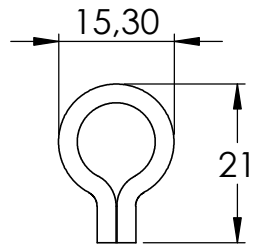

SCHNITT B-B

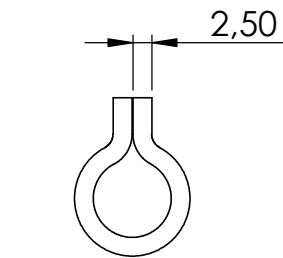
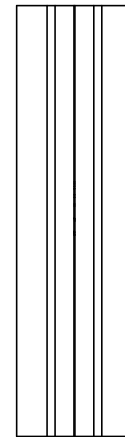
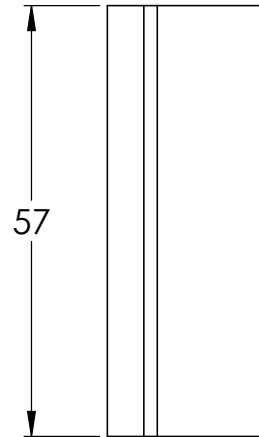
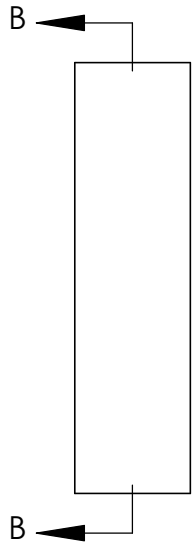

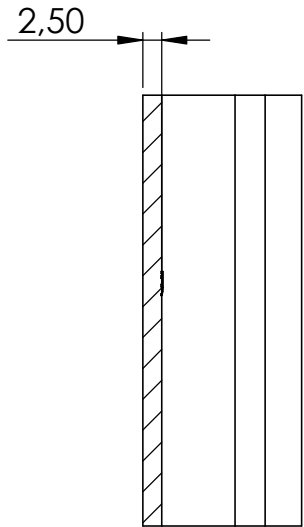
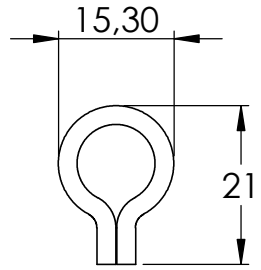

SCHNITT C-C

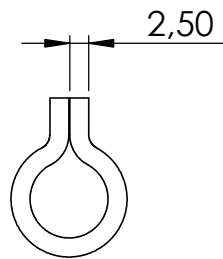
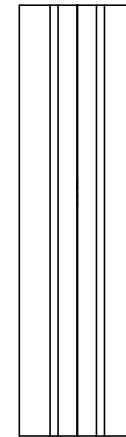
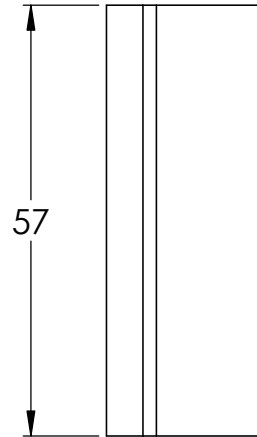
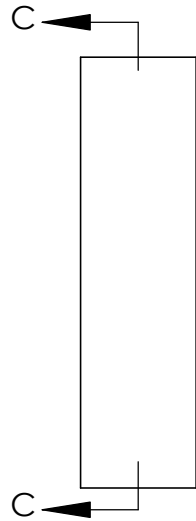

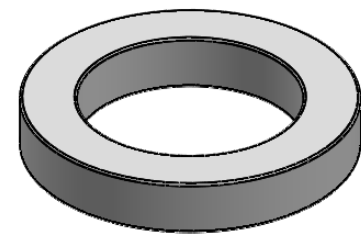
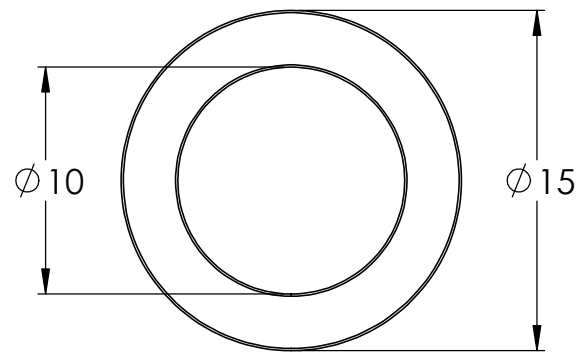

4

402-12 Teil4

1

1

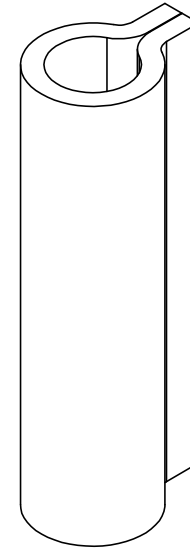
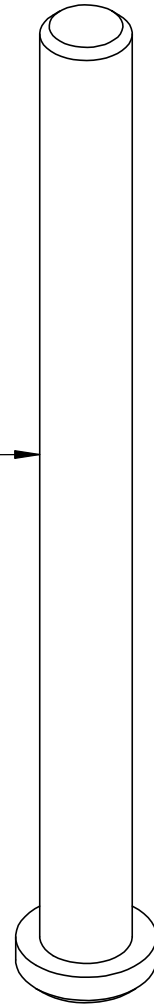

3

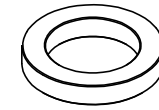

4

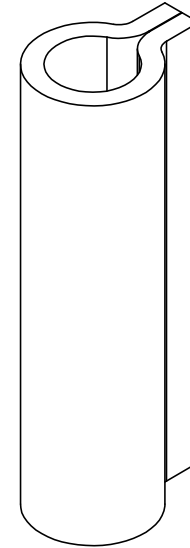

2