

Tragkraft: 200kg  
Gilt für 2 Bänder

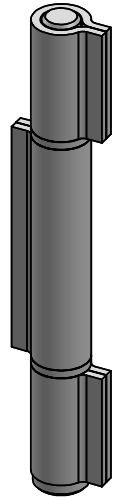

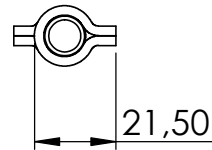

SCHNITT A-A

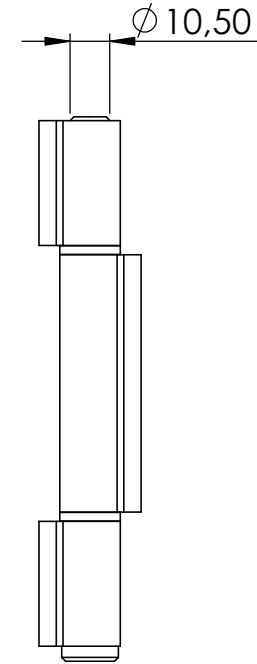
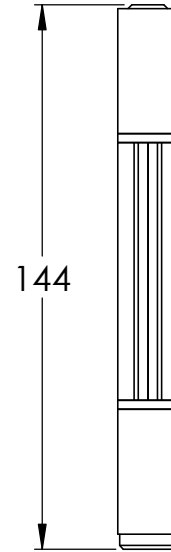
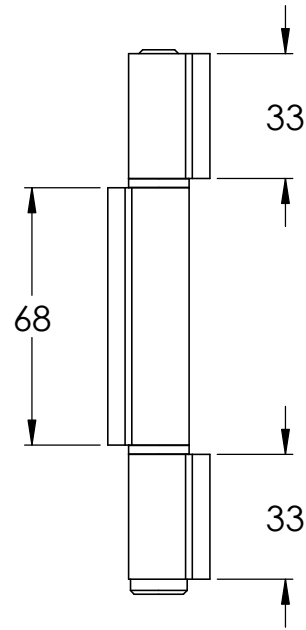
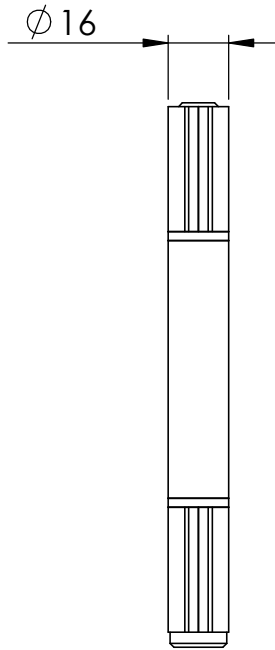
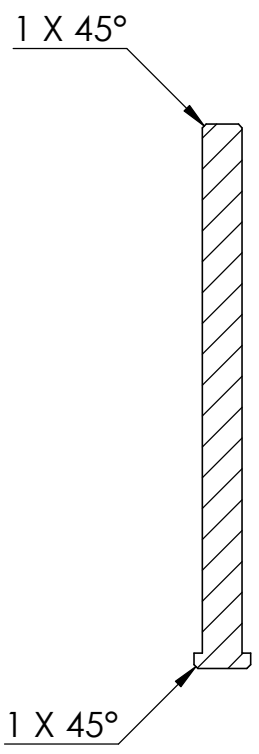
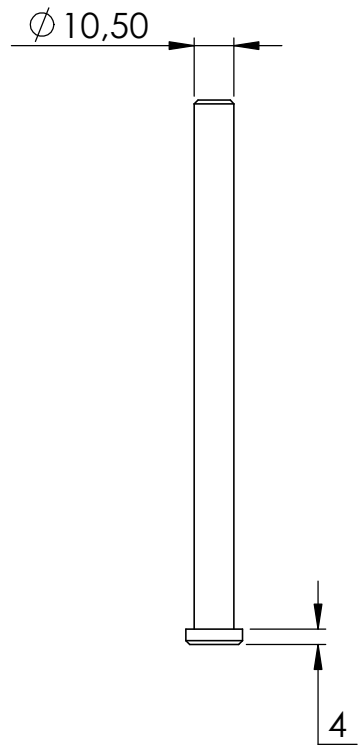
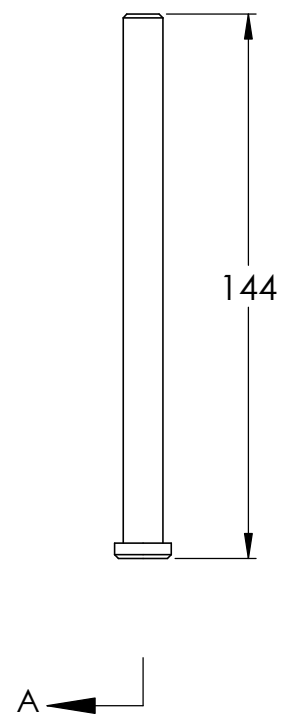
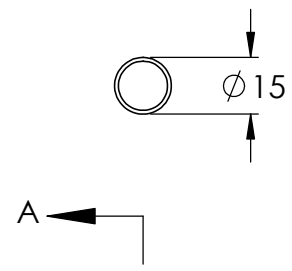

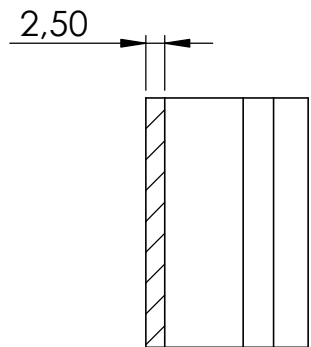
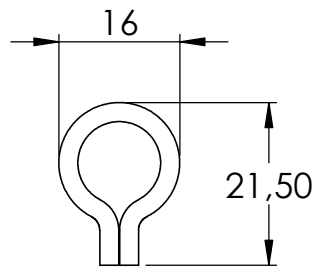

SCHNITT B-B

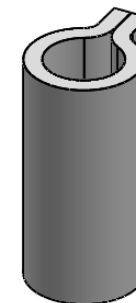
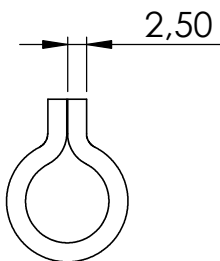
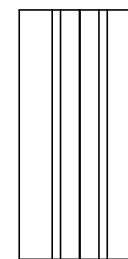
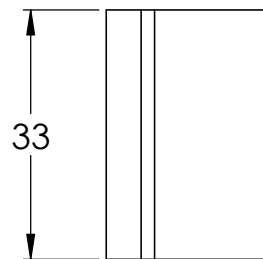
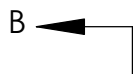

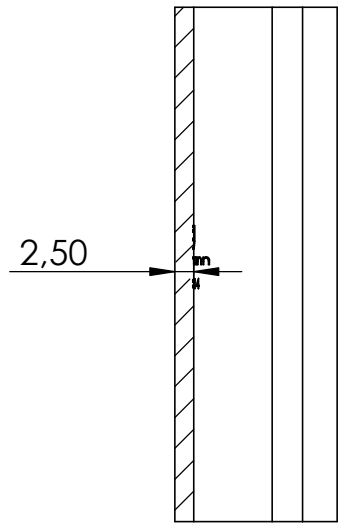
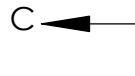
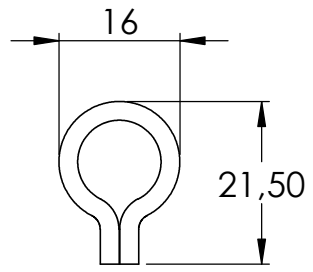

SCHNITT C-C

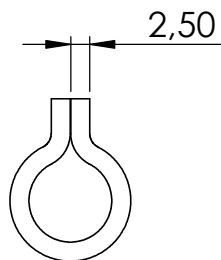
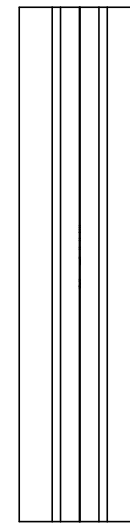
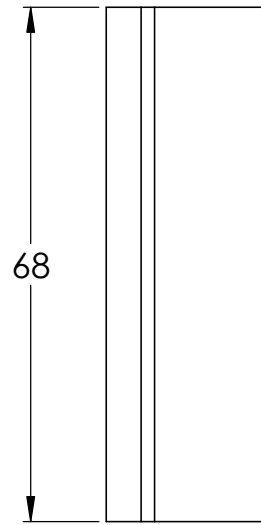
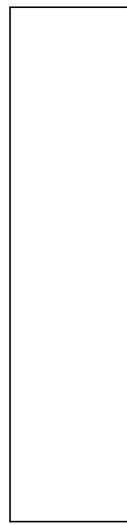

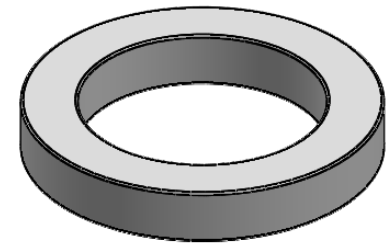
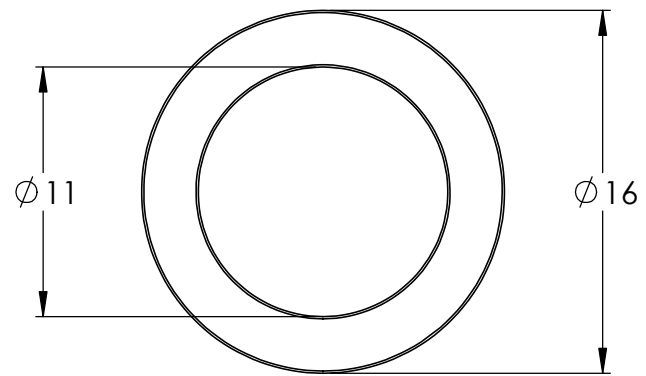
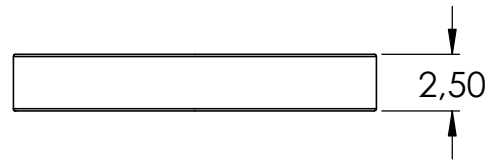

4

410-14 Teil3

1

