

\* empfohlener  
Glaseinstand

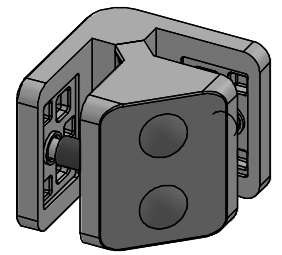

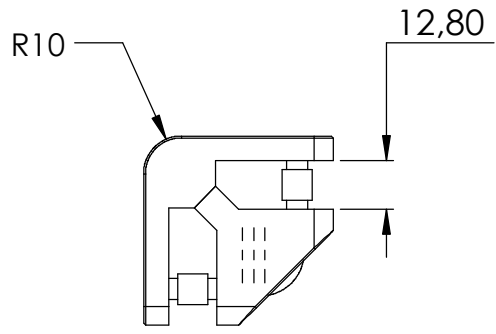

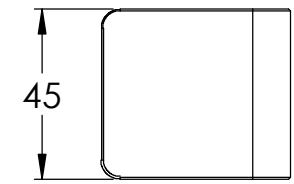
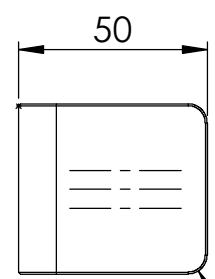
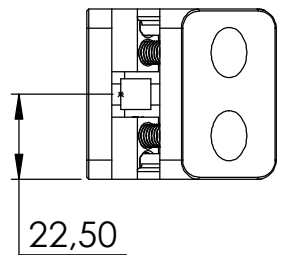
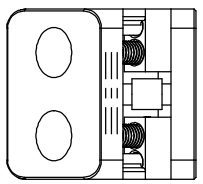
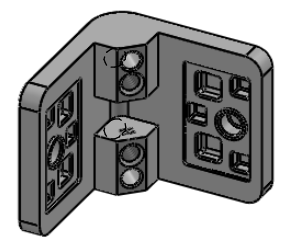
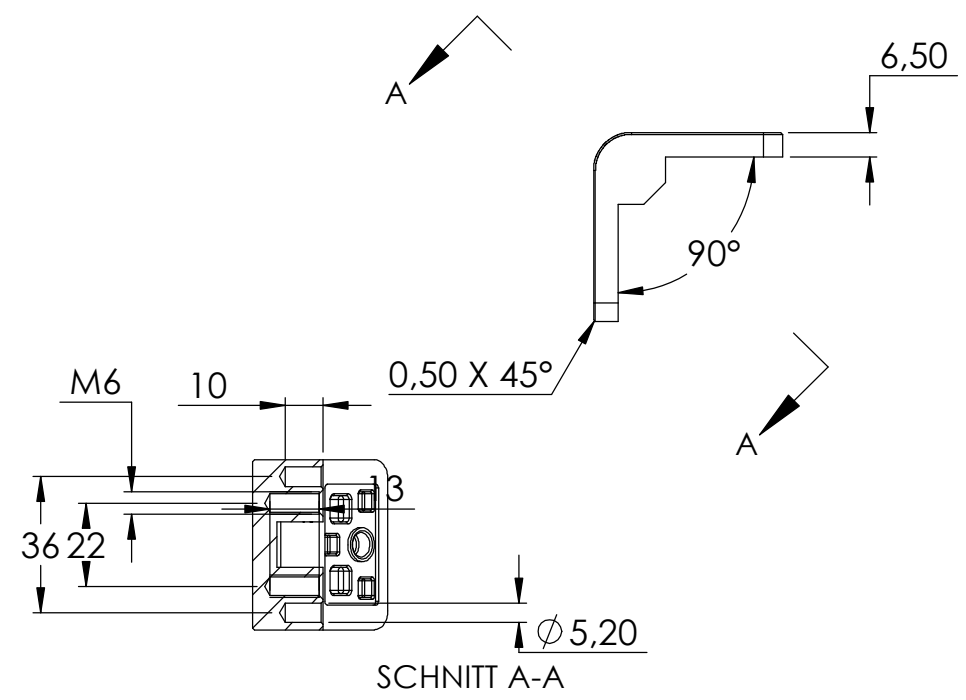
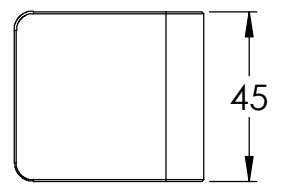
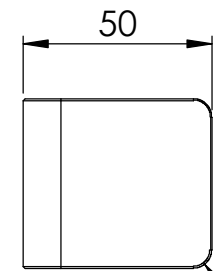
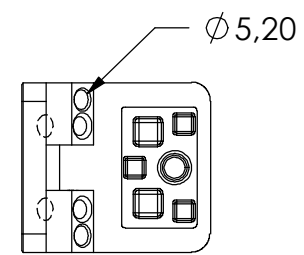
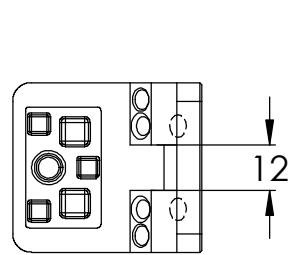
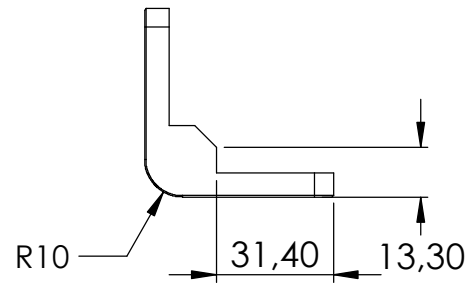
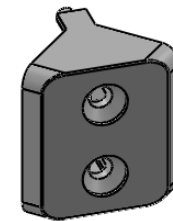
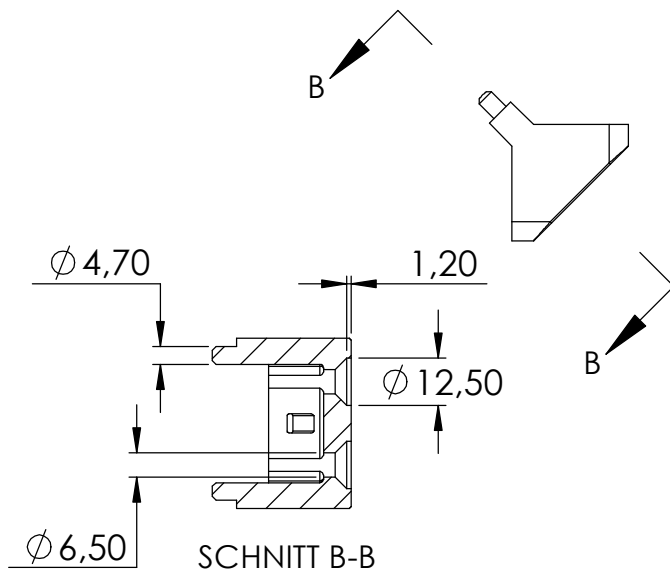
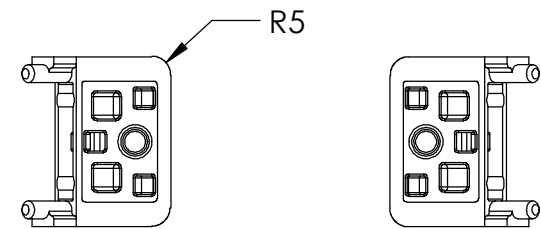
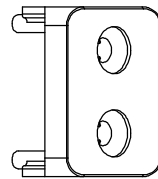
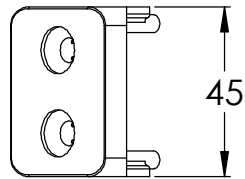
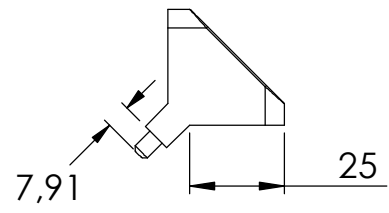

|   |                               |   |
|---|-------------------------------|---|
| 4 | DIN 7991 - M6 x 40 ---<br>40S | 2 |
| 5 | 27-STIFT-OR                   | 2 |
|   | 27-STIFT Teil2                | 1 |

