

* empfohlener
Glaseinstand

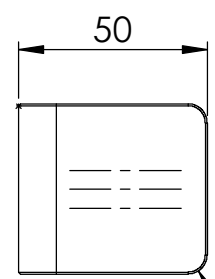

R5

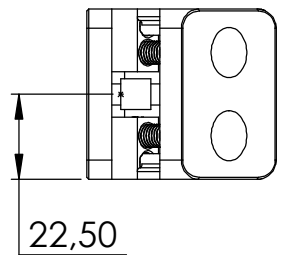

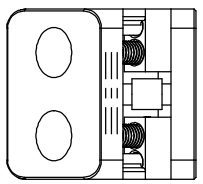
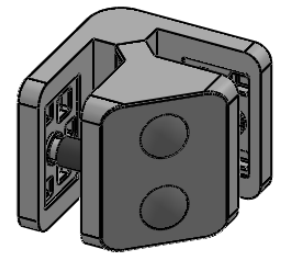
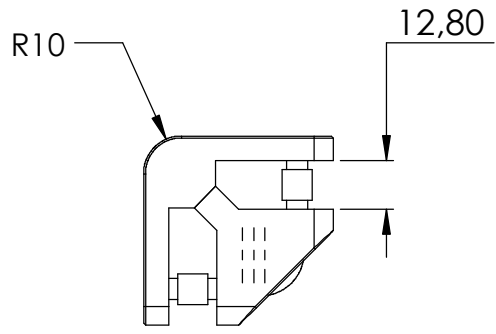
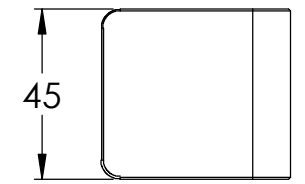
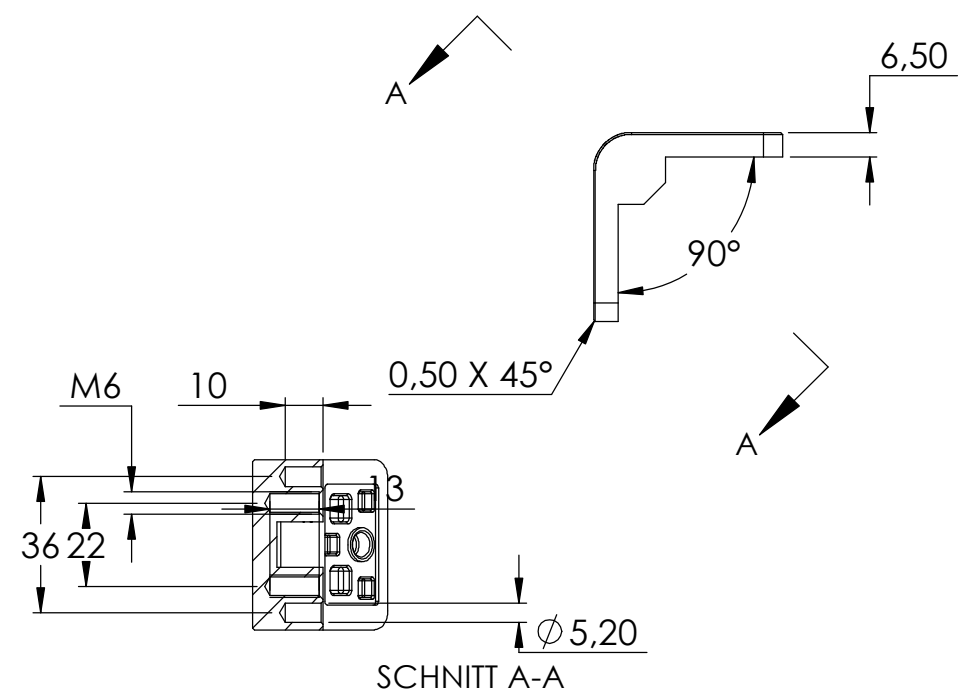
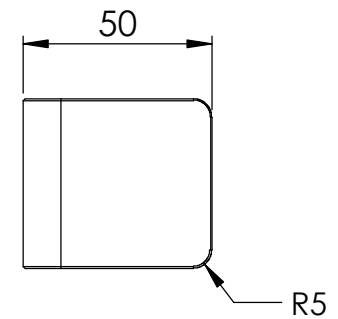
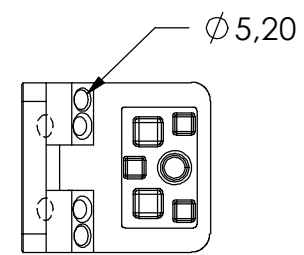
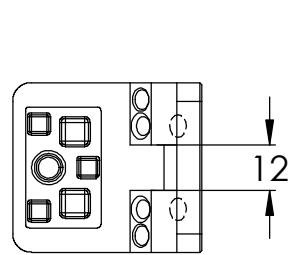
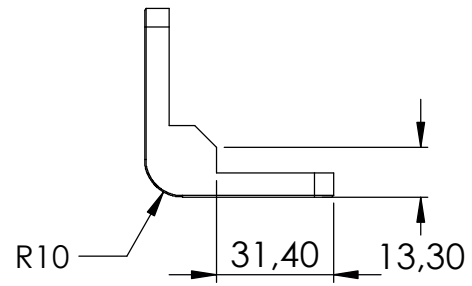

SCHNITT A-A

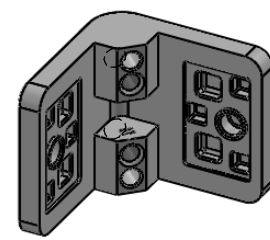

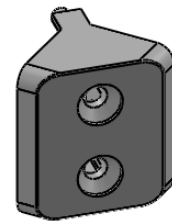
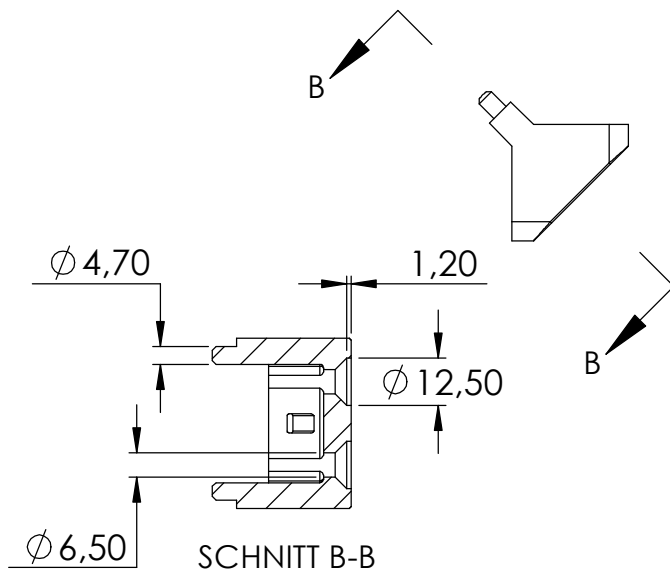
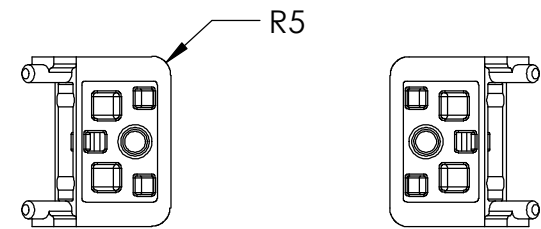
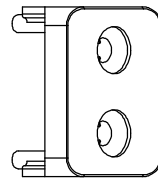
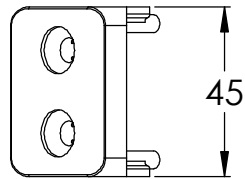
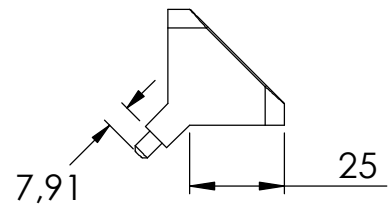

4	27-Kappe	2
5	27-STIFT-OR	2
	27-STIFT Teil2	1

