

Tragkraft: 150kg
Gilt für 2 Bänder

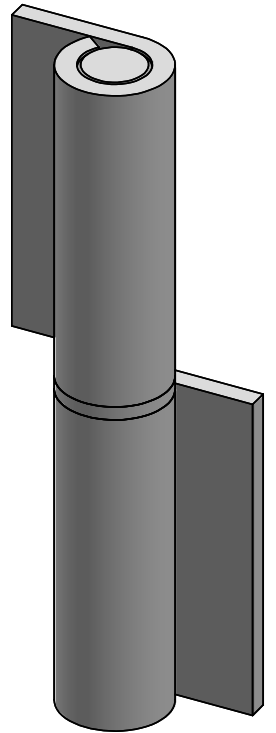

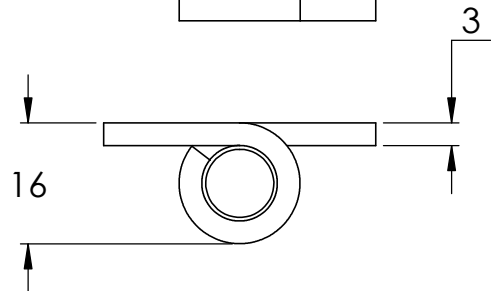

0,50 X 45°

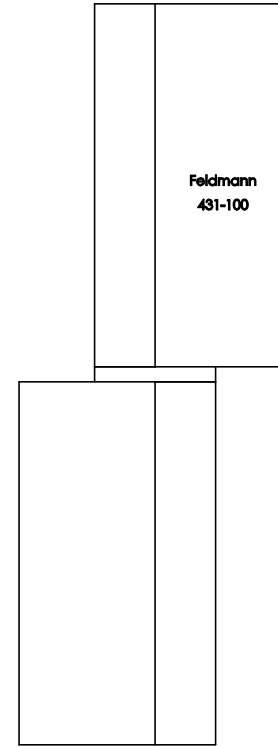
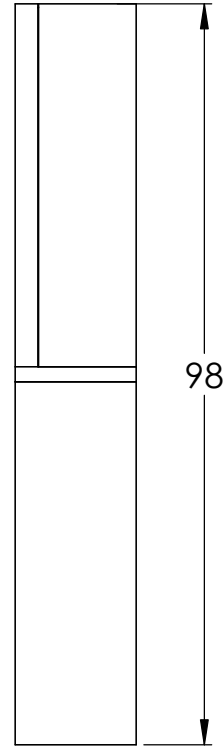
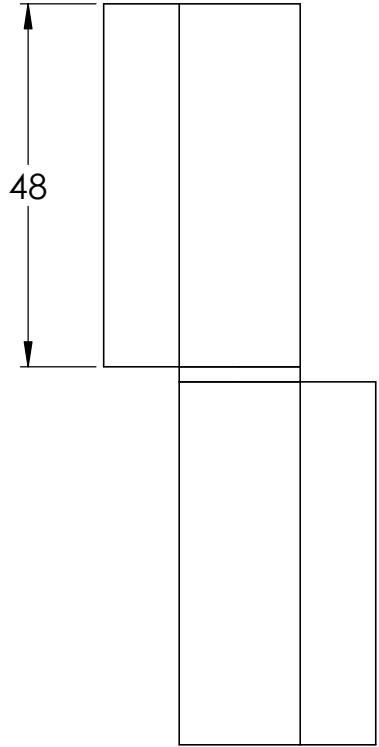
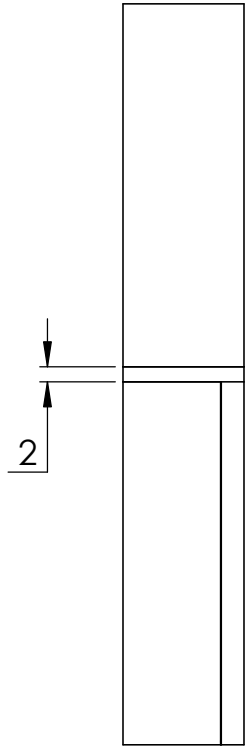
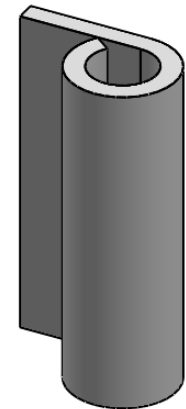
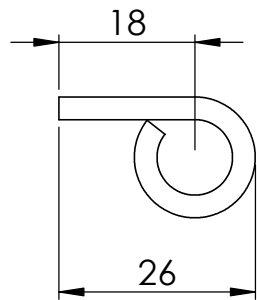
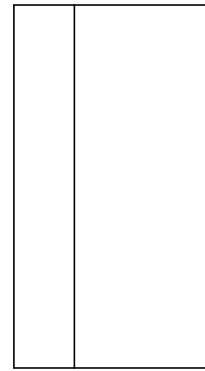
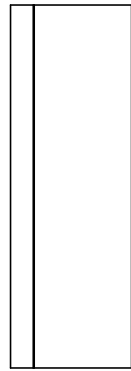
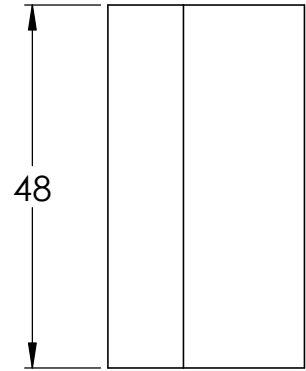
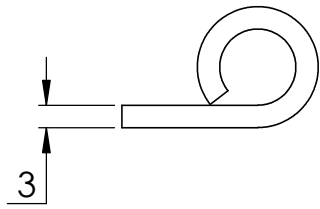
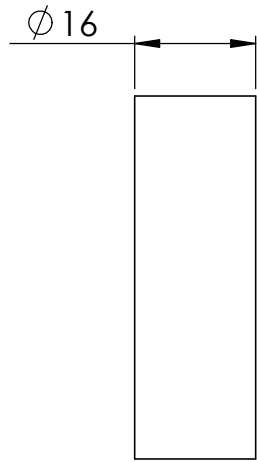
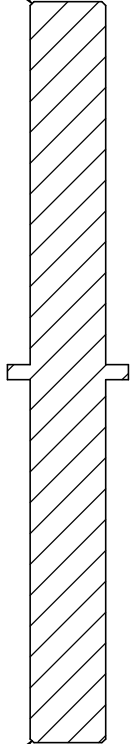

0,50 X 45°

SCHNITT A-A

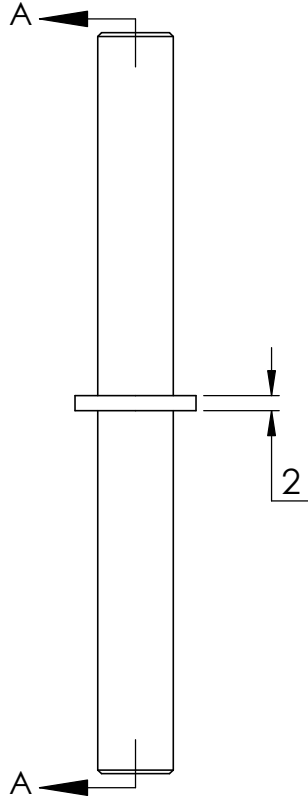
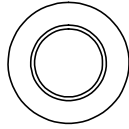

∅10

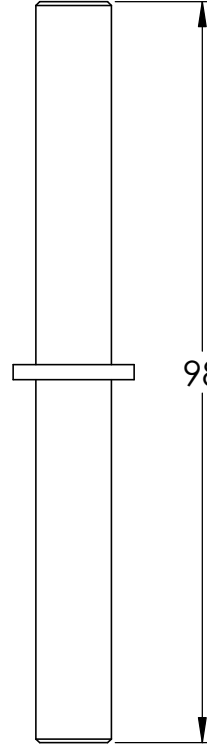

98

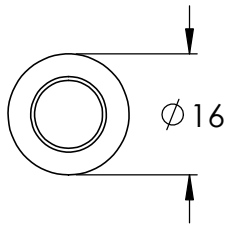

∅16

