

Tragkraft: 250kg  
Gilt für 2 Bänder

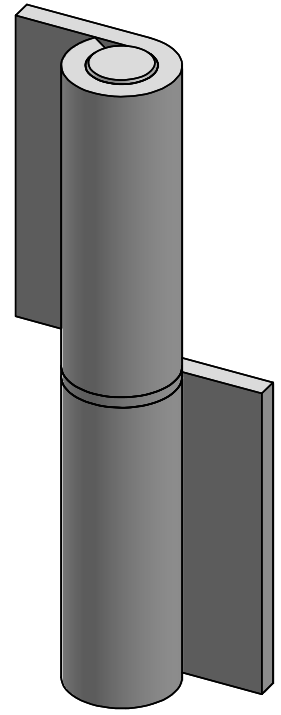

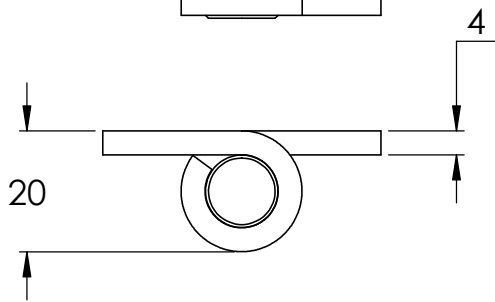

0,50 X 45°

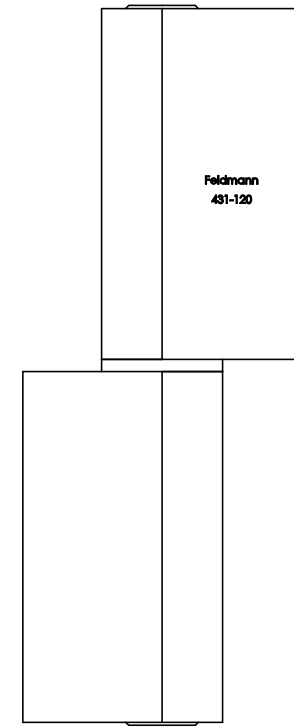
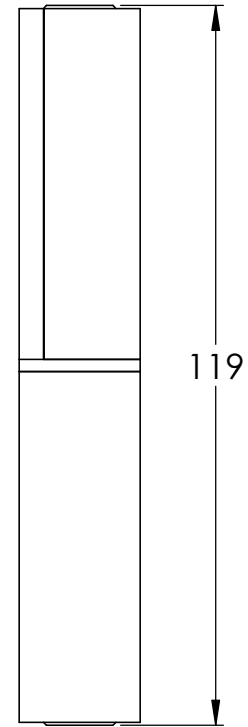
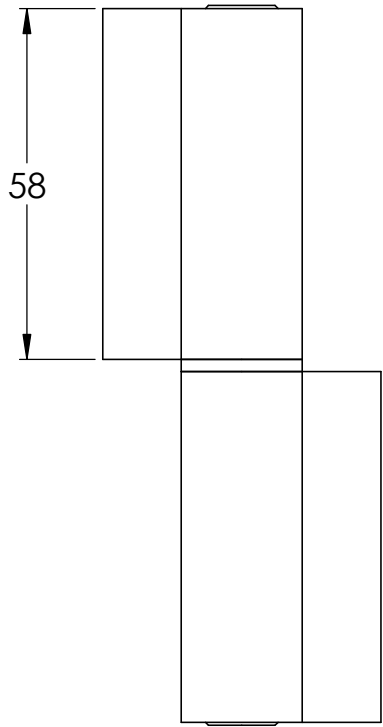
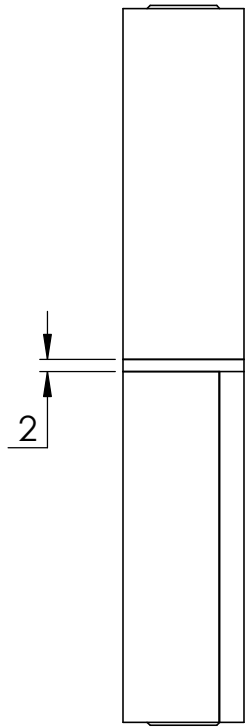
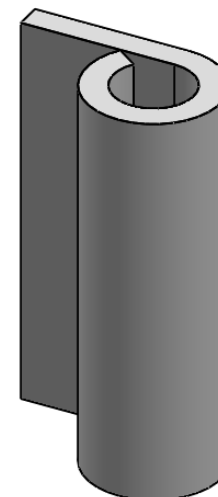
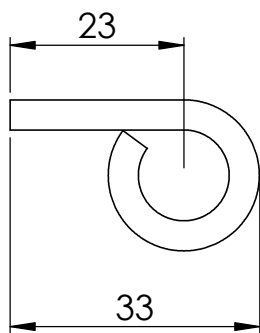
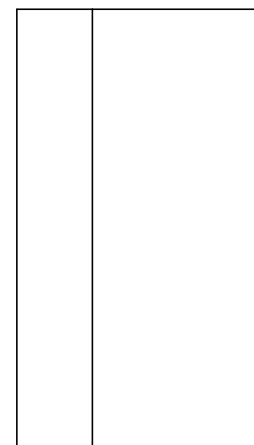
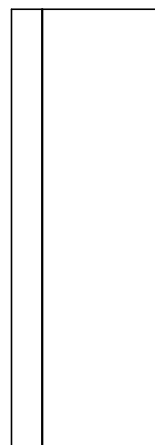
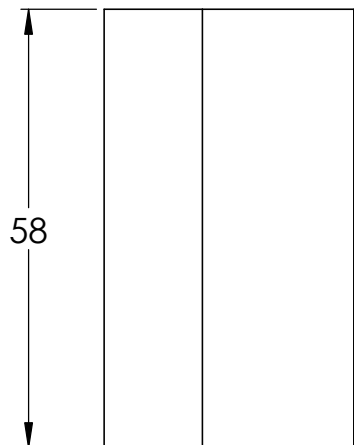
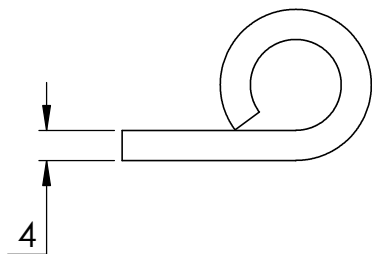
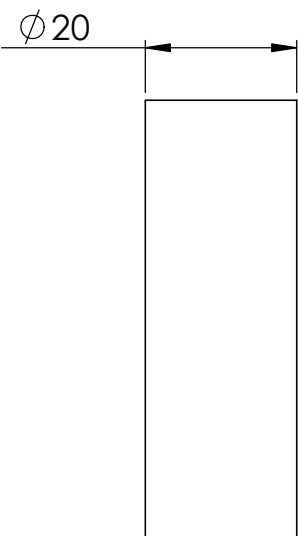
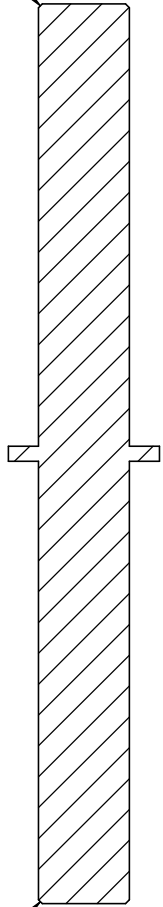

0,50 X 45°

SCHNITT A-A

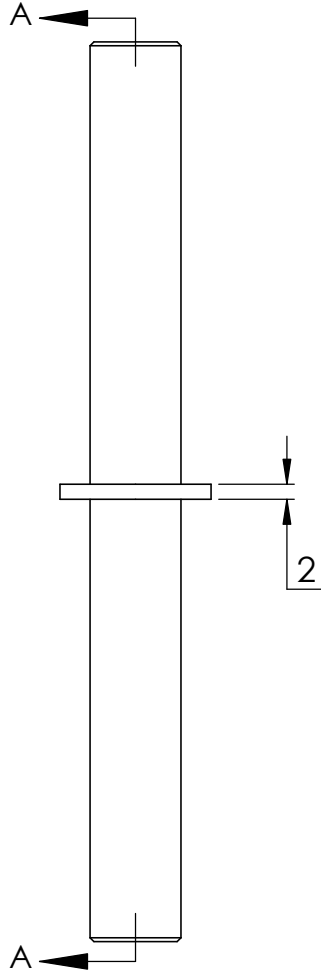
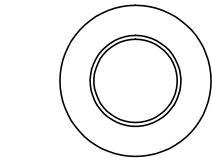

$\phi 12$

119

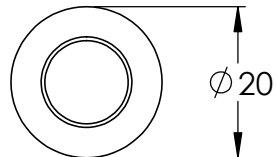

$\phi 20$

