

$\varnothing 10,10$ R11

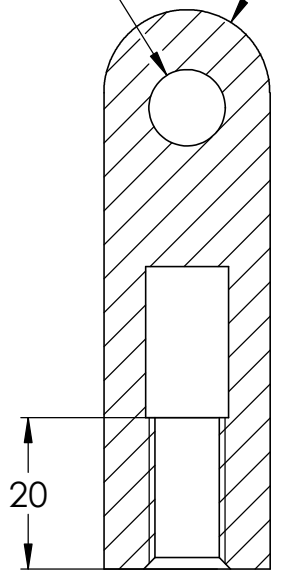

SCHNITT C-C

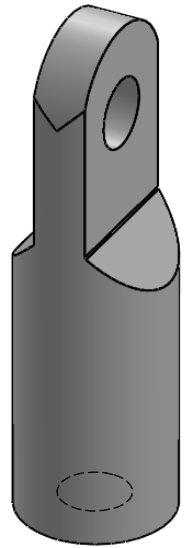

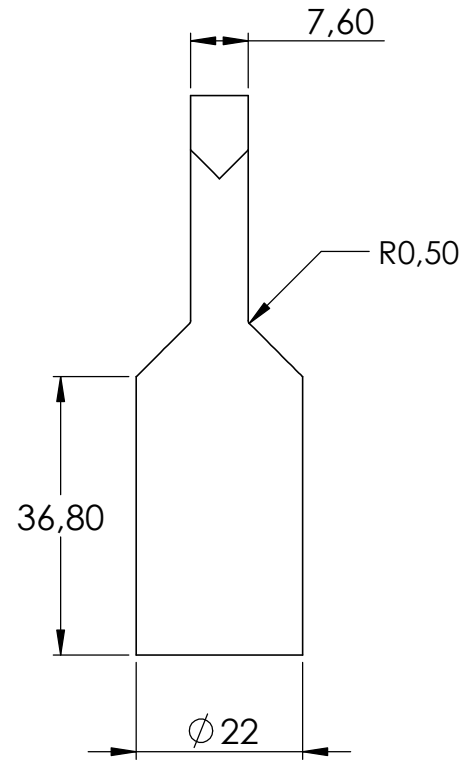
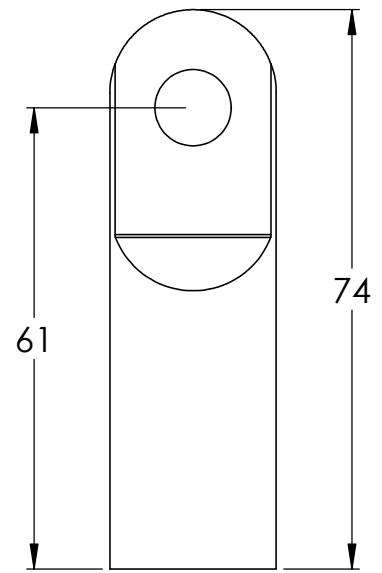
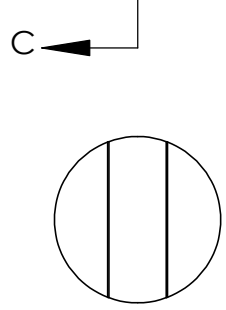
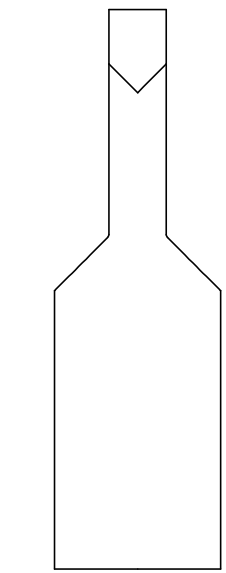
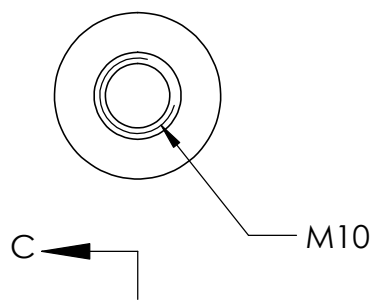
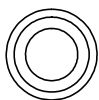
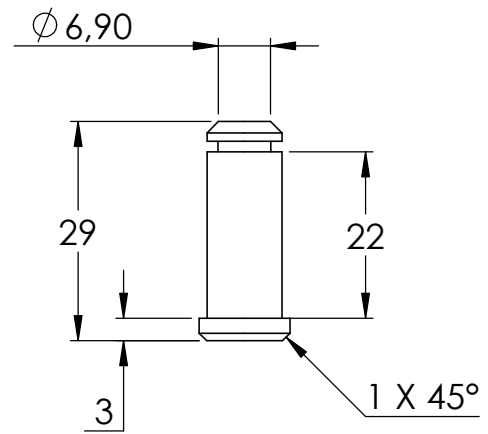
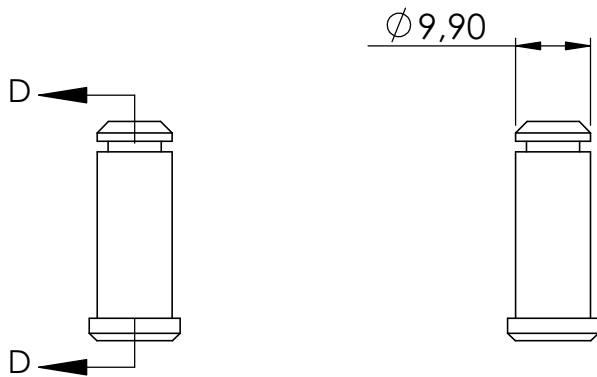
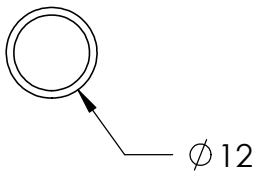
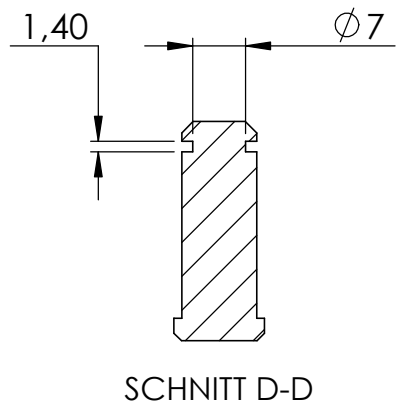

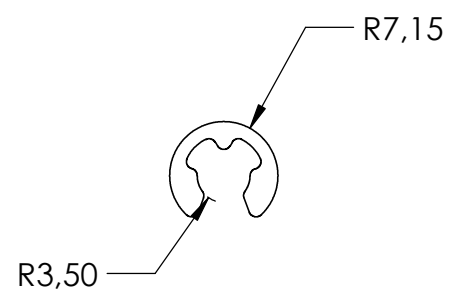
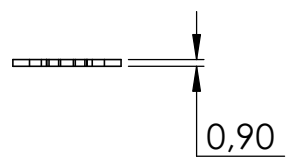

4

DIN 6799 7

1

