

Tragkraft: 110kg
Gilt für 2 Bänder

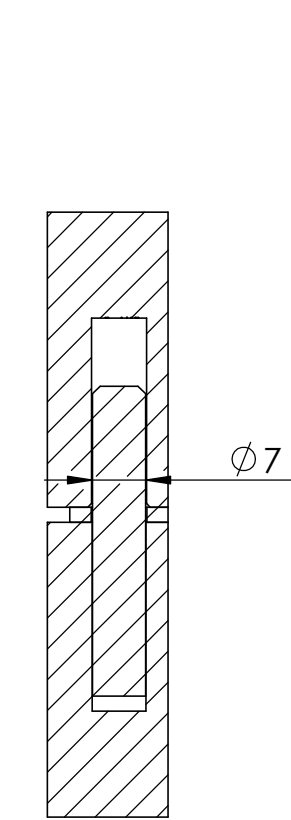

SCHNITT A-A

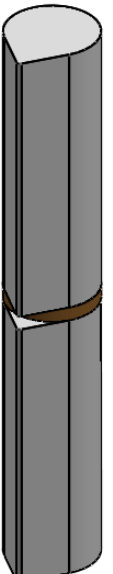
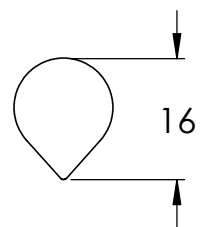
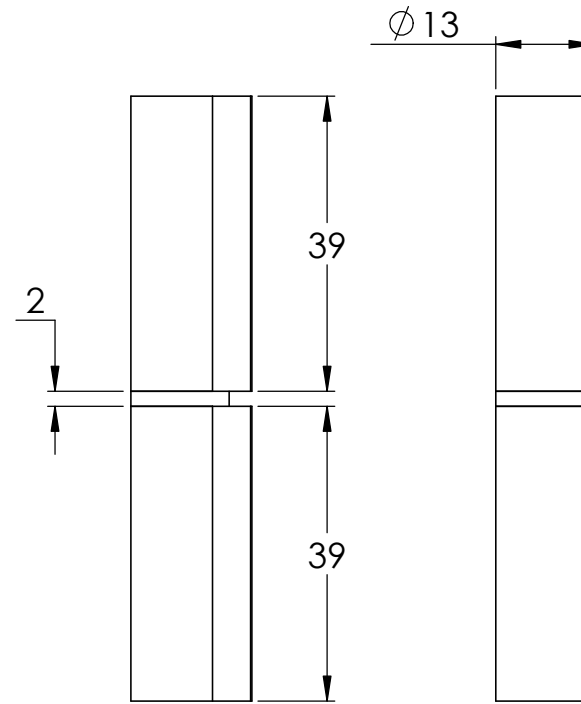
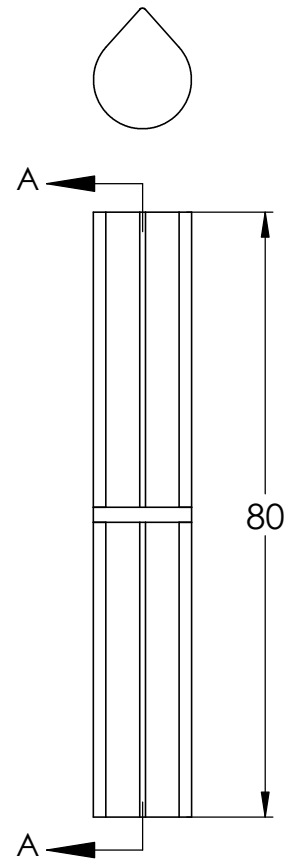

1 X 45°

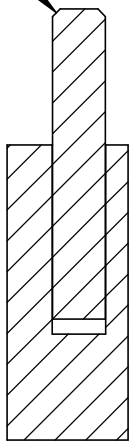

SCHNITT B-B

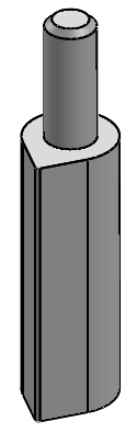
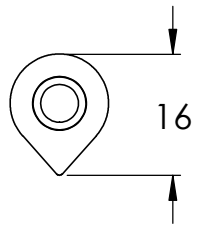
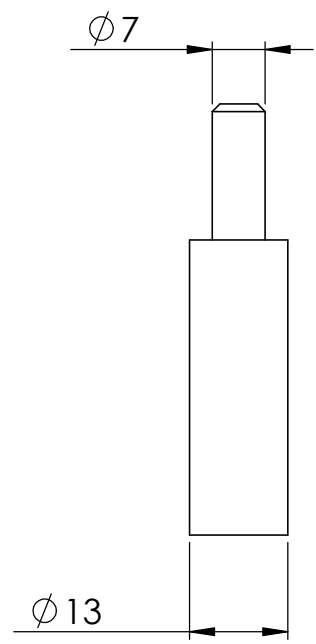
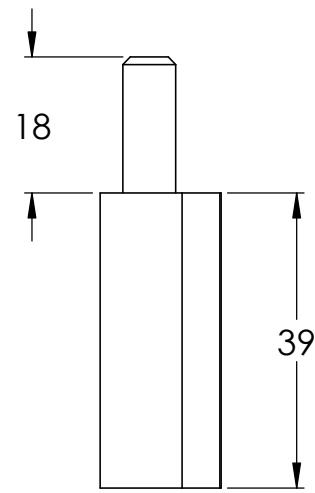
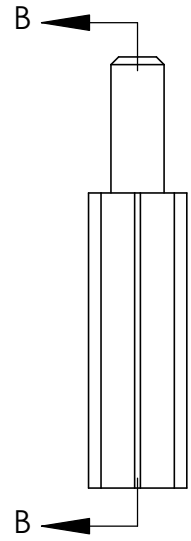
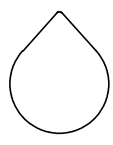

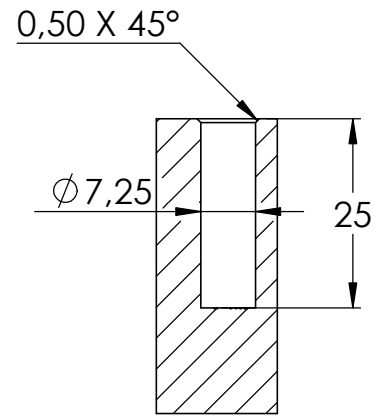
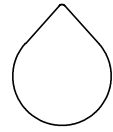

SCHNITT C-C

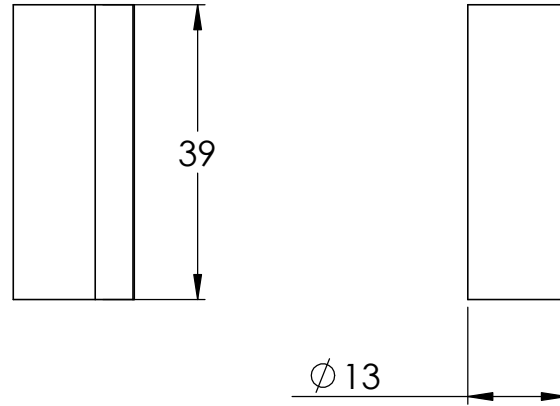
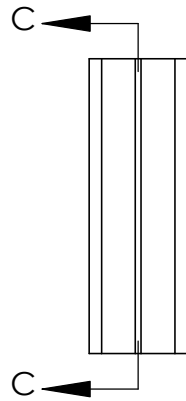

$\phi 13$

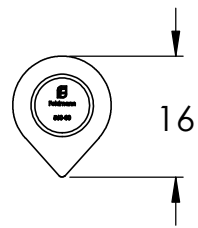

16

