

SCHNITT A-A

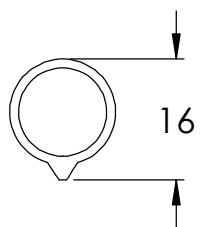

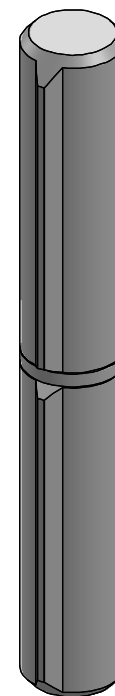

SCHNITT B-B

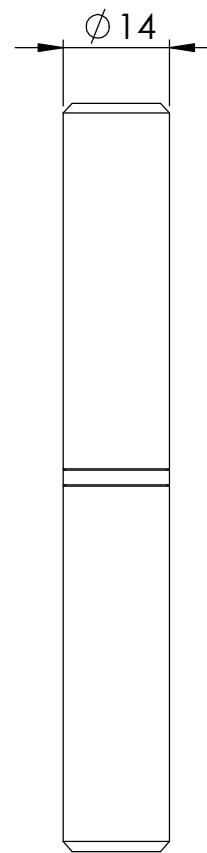
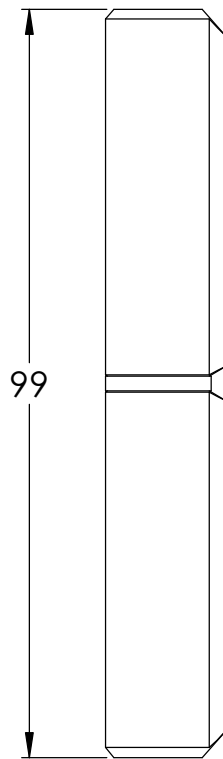
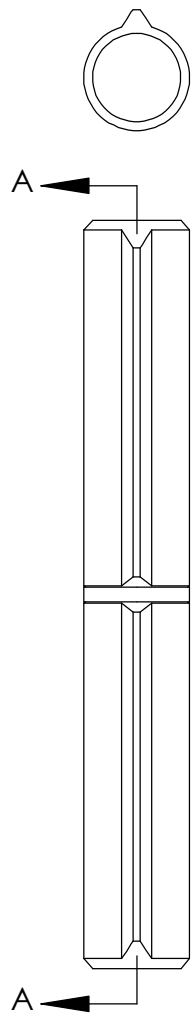
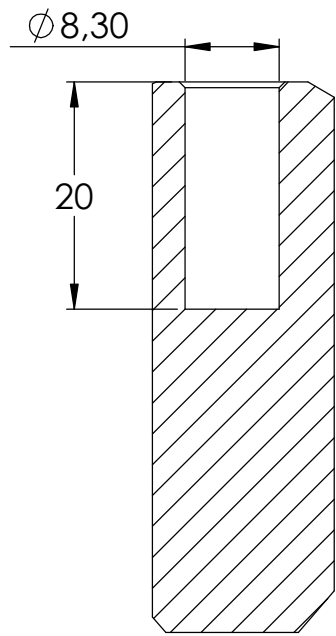
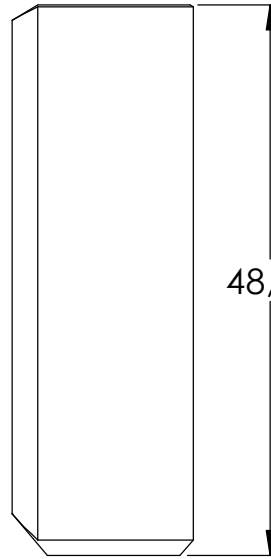
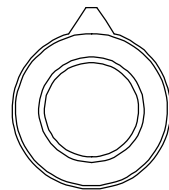
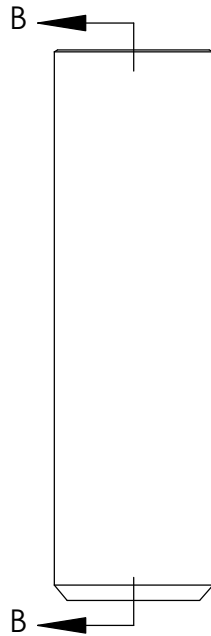
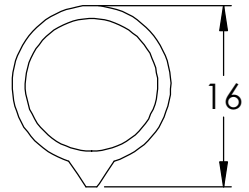

48,50

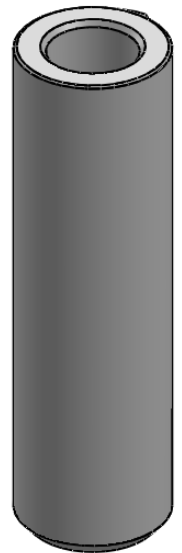
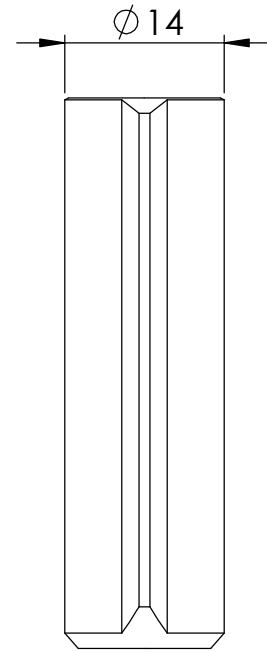

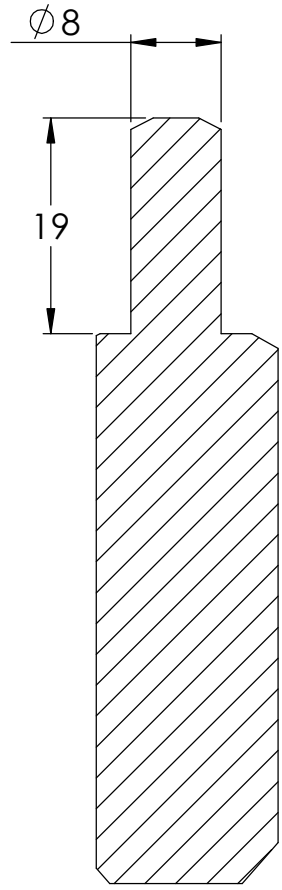

SCHNITT C-C

