

D-D

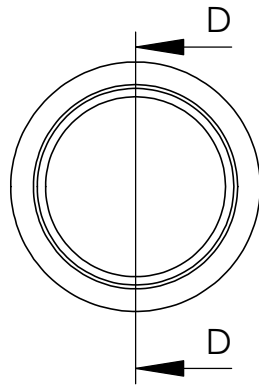

$0,50 \times 45^\circ$

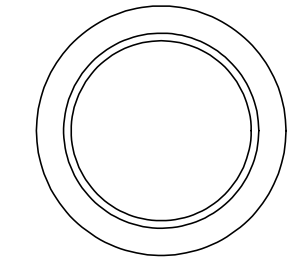

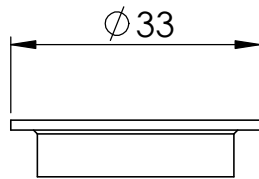
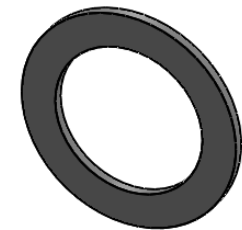
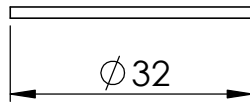
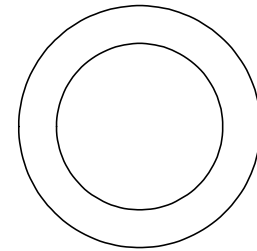
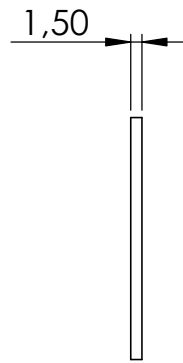
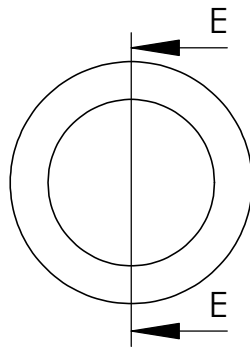
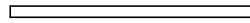
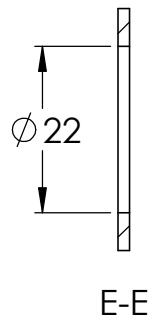

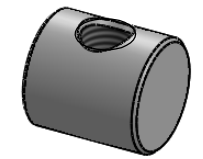
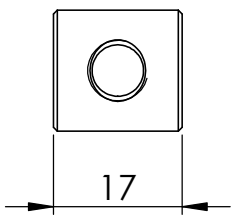
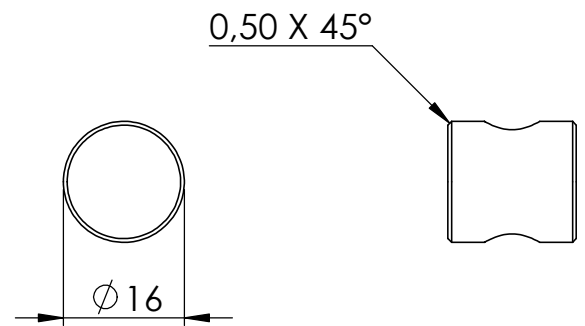
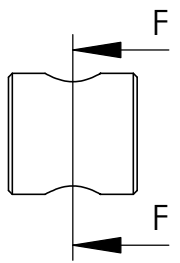
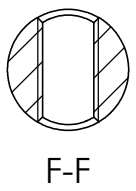
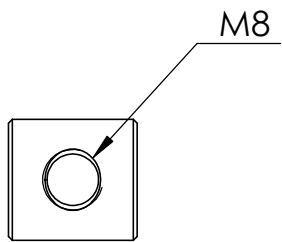

4	60821-240 Teil4	1
5	60821-240 Teil5	1
6	DIN 912 M8 x 20 --- 20S	1

