

$\varnothing 12,50$

M8

9

40,18

19,68

R2

3°

3

1

3,50

$\varnothing 4,20$

$\varnothing 30$

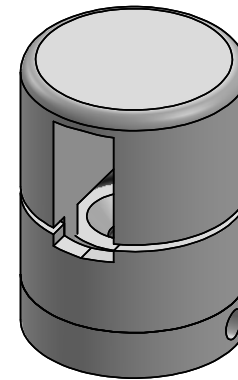

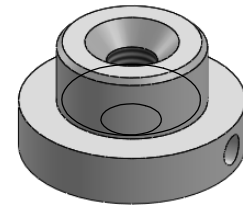
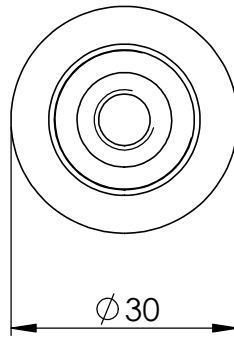
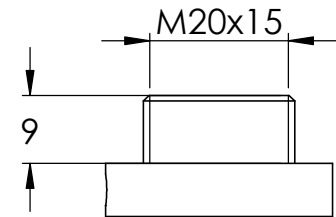
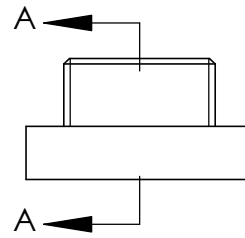
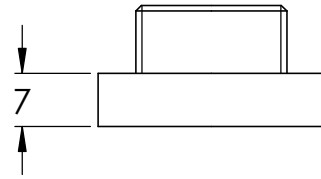
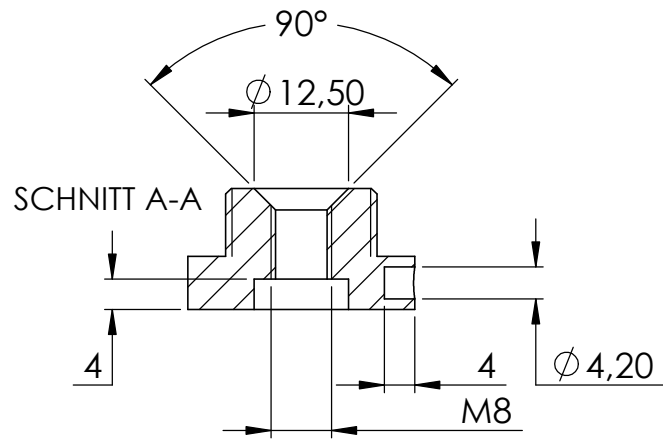
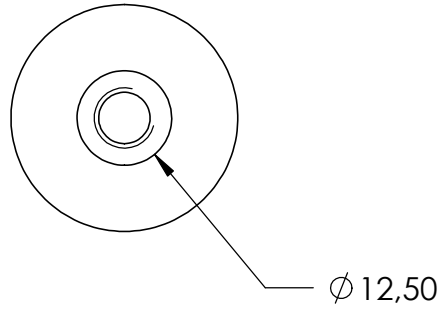

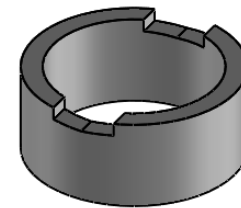
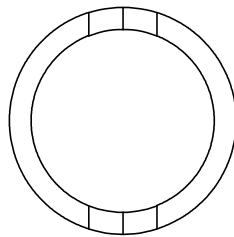
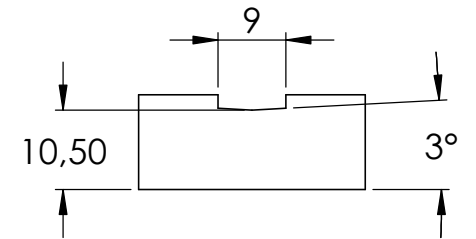
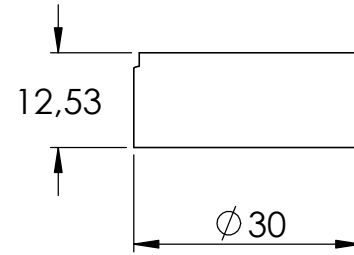
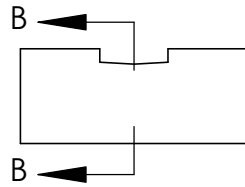
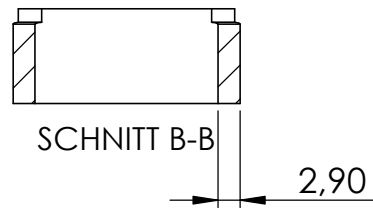
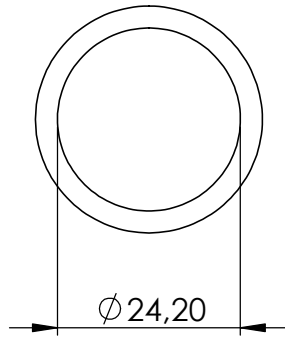

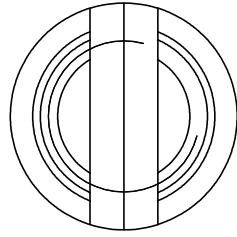

SCHNITT C-C

