

$\phi 12,50$

M8

7

50,24

29,74

R2

3°

3

1

3,50

$\phi 4,20$

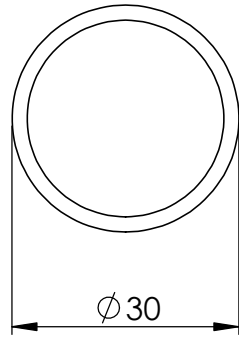

$\phi 30$

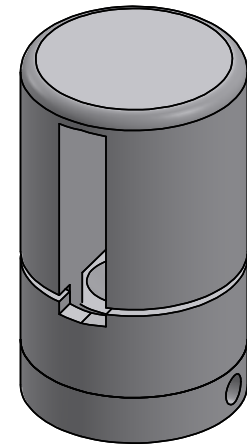

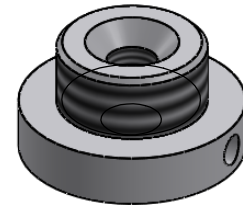
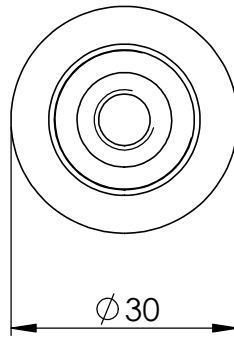
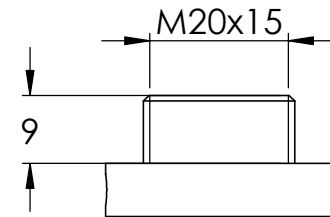
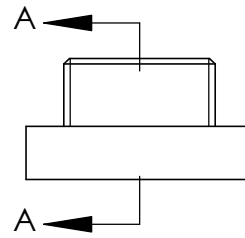
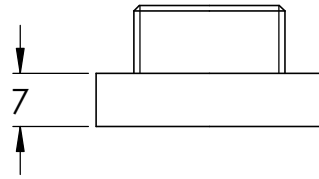
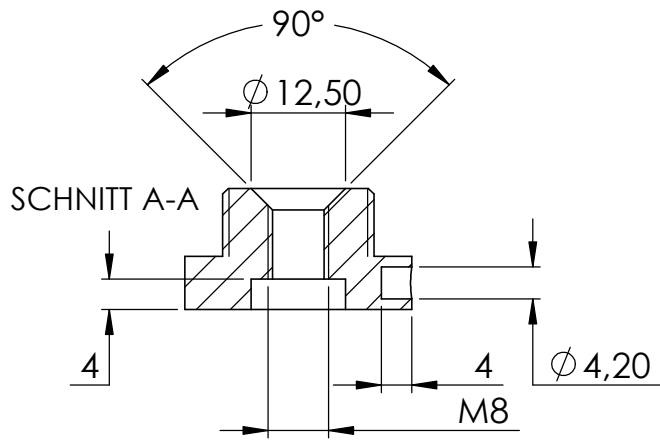
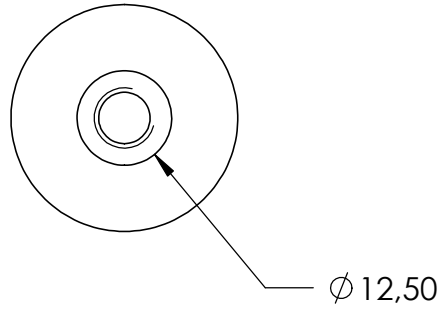

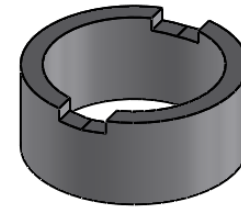
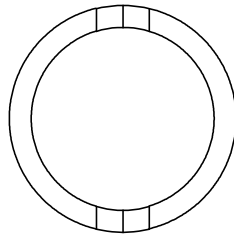
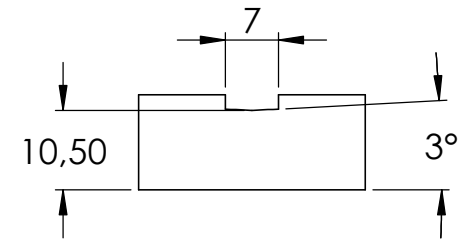
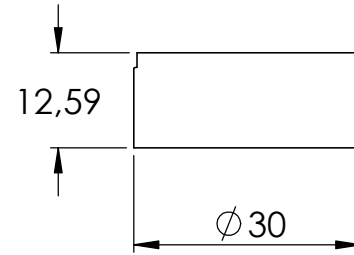
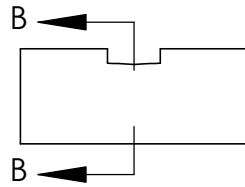
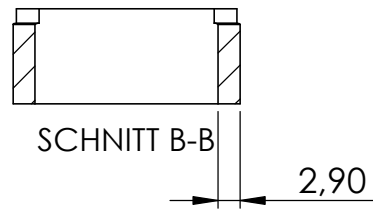
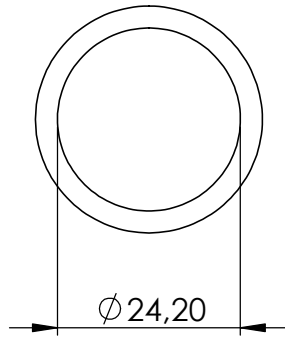

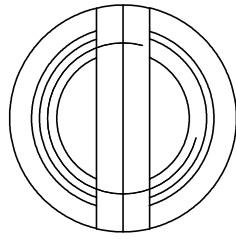

SCHNITT C-C

