

$\phi 12,50$

M8

7

R2

60,24

39,74

3°

3

1

3,50

$\phi 4,20$

$\phi 30$

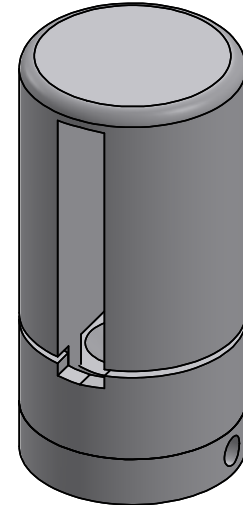

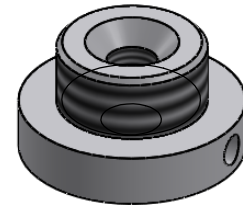
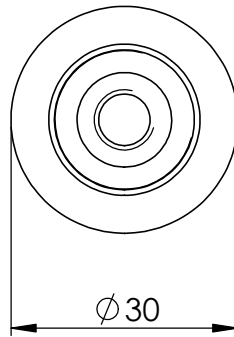
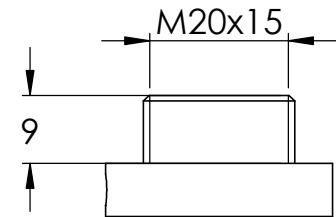
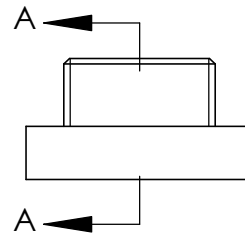
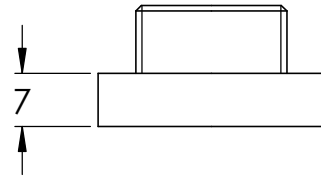
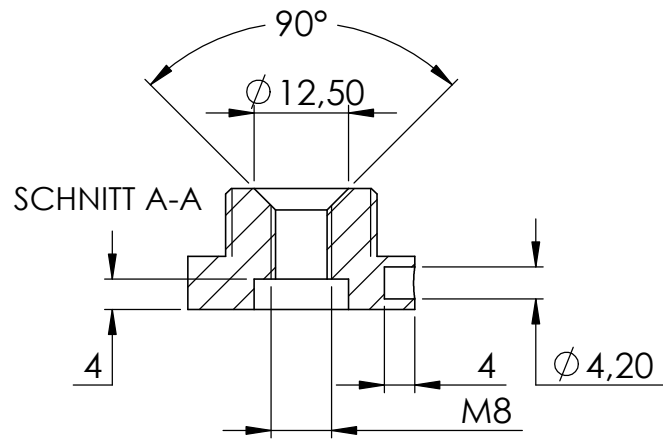
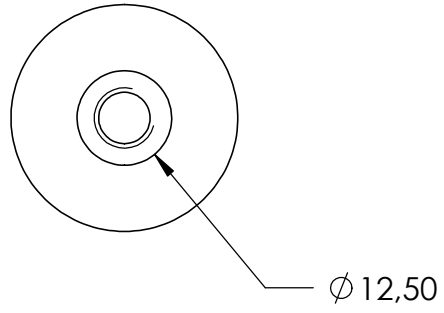

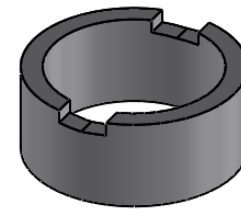
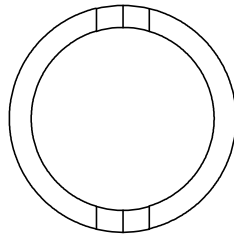
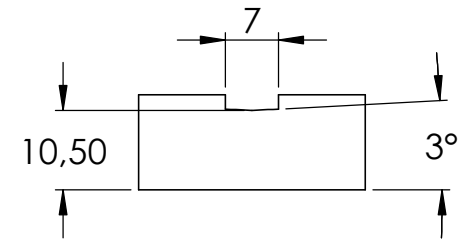
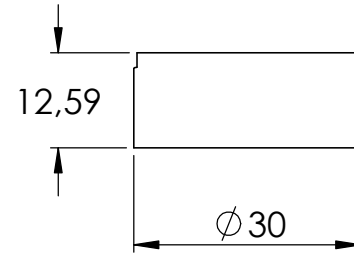
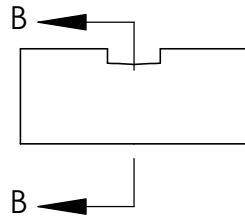
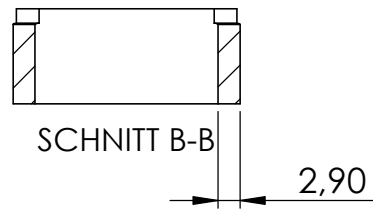
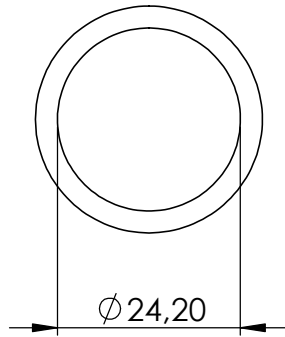

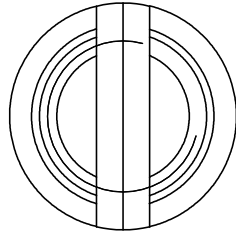

SCHNITT C-C

