

Ø 12,50

M8

9

R2

60,34

39,84

3°

3

1

3,50

Ø 4,20

Ø 30

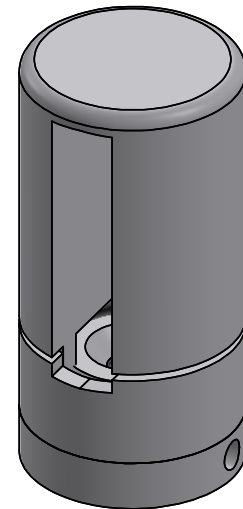

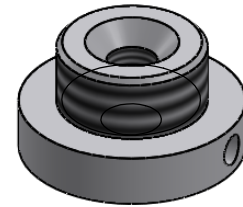
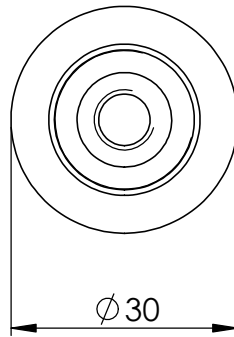
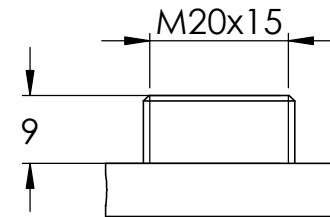
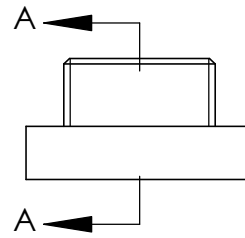
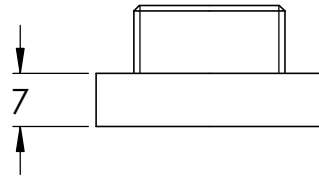
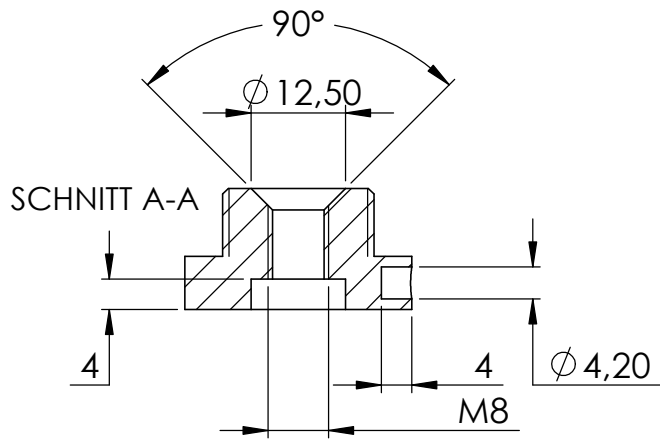
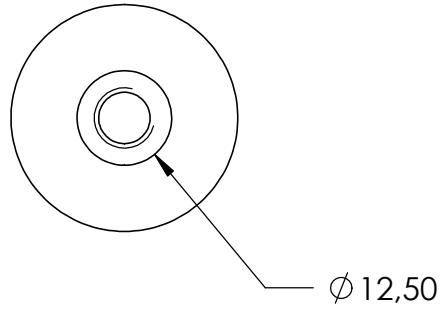

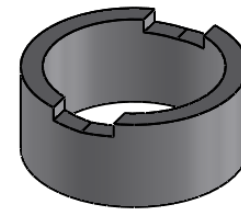
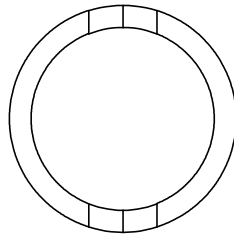
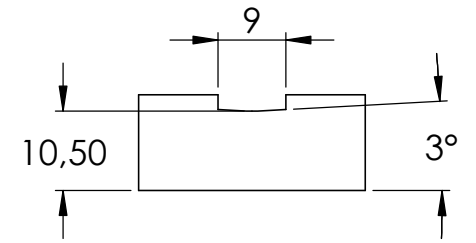
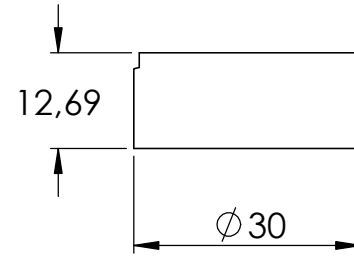
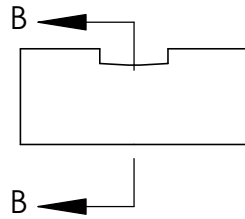
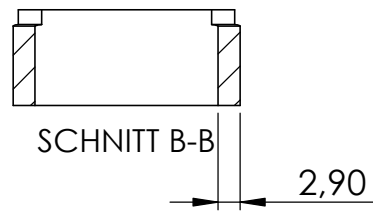
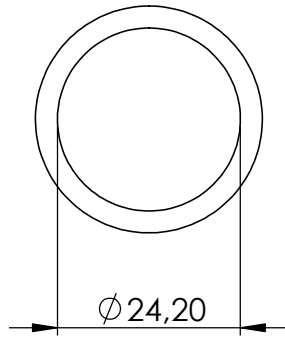

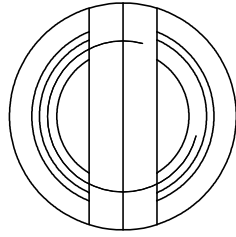

SCHNITT C-C

