

$\phi 12,50$

M8

11

R2

3°

3

70,45

49,95

1

3,50

$\phi 4,20$

$\phi 30$

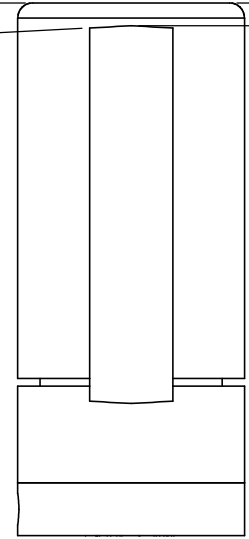
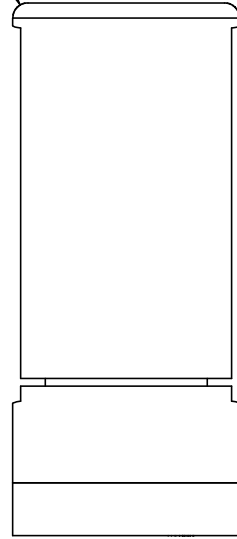
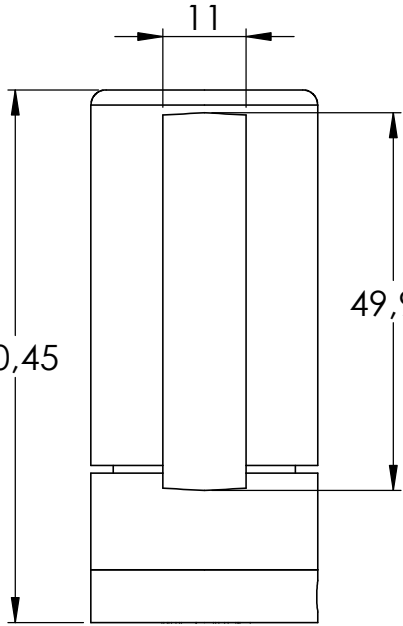
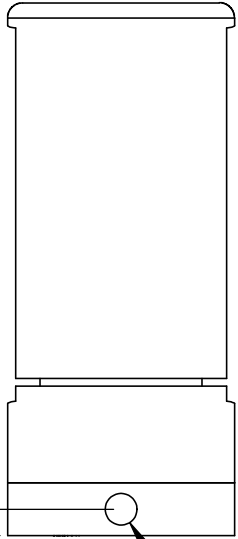
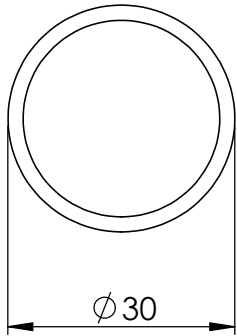
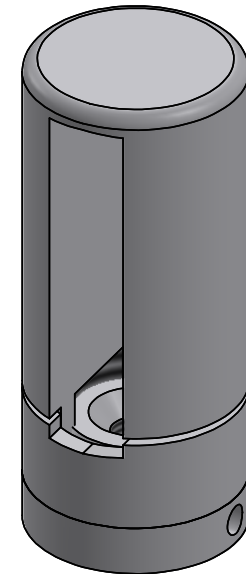

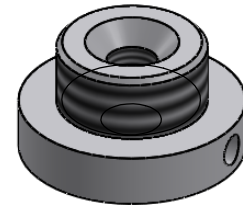
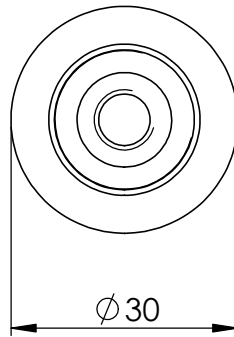
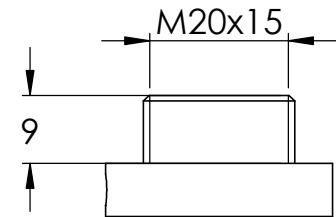
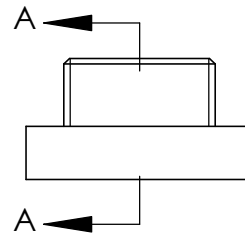
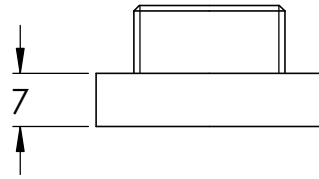
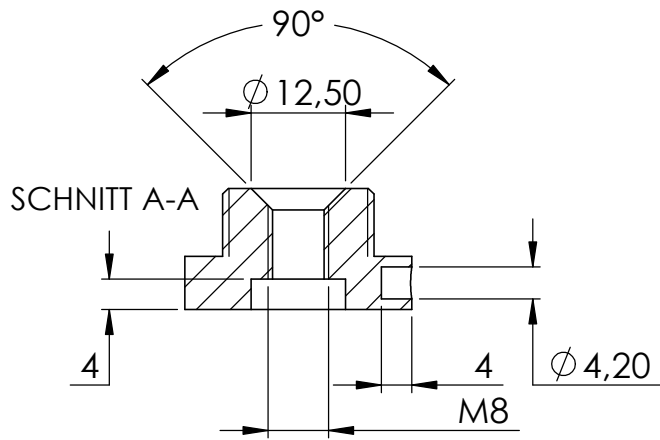
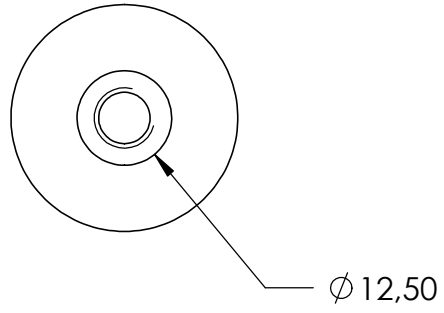

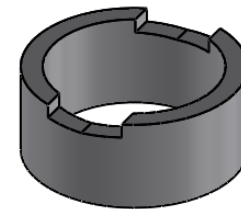
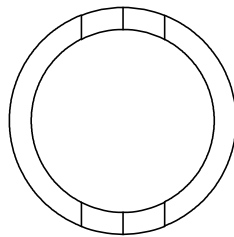
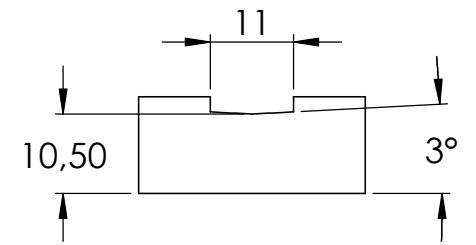
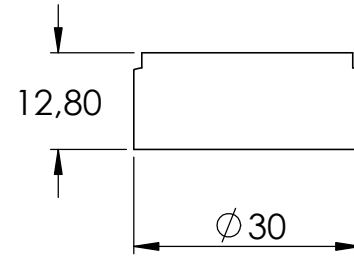
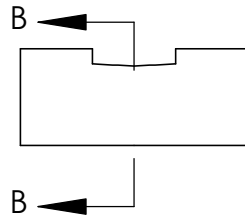
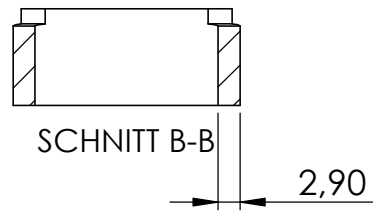
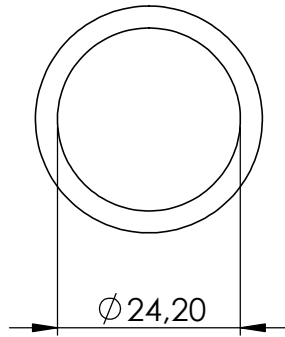

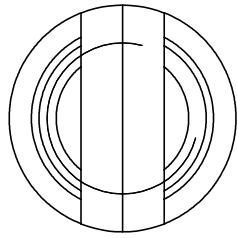

SCHNITT C-C

